

V

V-Series

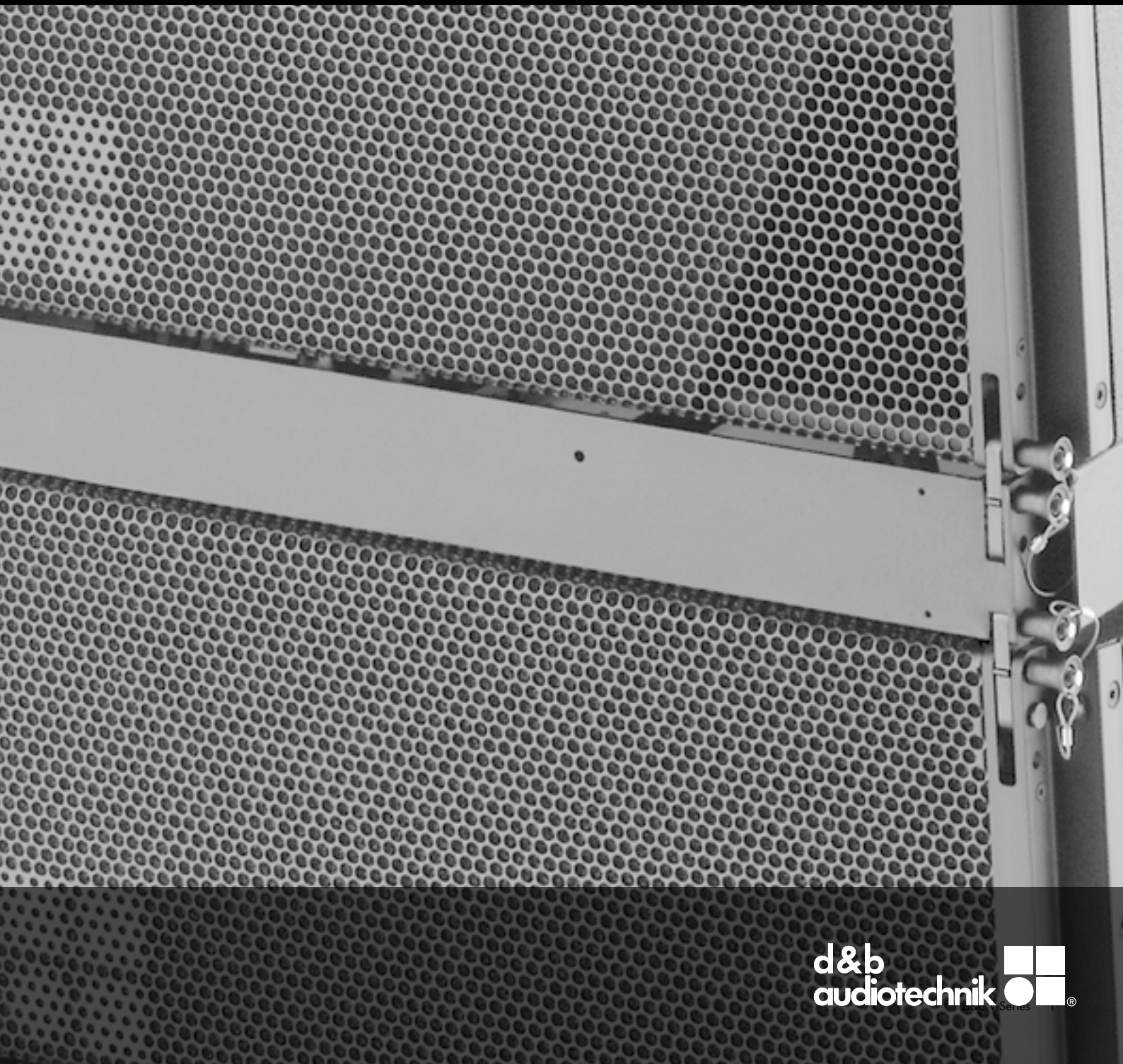



The d&b System reality	4
The V-Series	6
The V7P loudspeaker and Vi7P loudspeaker	10
The V10P loudspeaker and Vi10P loudspeaker	11
The V-GSUB and Vi-GSUB	12
The V7P, V10P and V-GSUB transport accessories	13
The V8 loudspeaker and Vi8 loudspeaker	14
The V12 loudspeaker and Vi12 loudspeaker	15
The V subwoofer and Vi subwoofer	16
The Vi Weather Resistant, Special Colour and Custom solutions options	17
The V-Series mounting accessories and examples	18
The V-Series rigging accessories and examples	20
The V8, V12 and V Flying frame cases and carts	23
The d&b ArrayCalc simulation software	24
The d&b NoizCalc immission modelling software	26
The d&b Remote network	27
The d&b amplifiers	28
The controller setups and operation with d&b amplifiers	30
The V-Series frequency responses	31
The d&b amplifier output modes	32
The DS10 and DS20 Audio network bridges	34
The DS100 Signal Engine	34
The V-Series configuration examples	35
The V-Series cables and adapters	42
The V-Series product overview	46

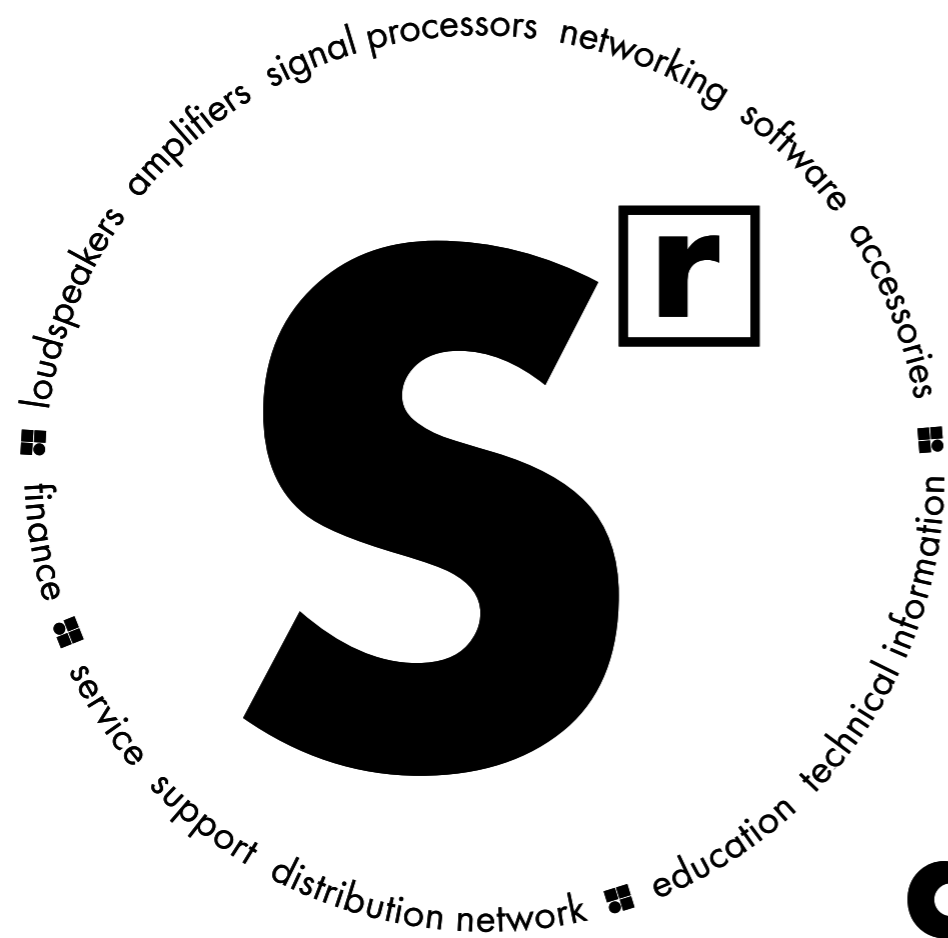

d&b System reality

As the name implies a d&b audiotechnik system is not just a loudspeaker. Nor is it merely a sum of the components: loudspeakers, amplifiers, signal processors, networking, software and accessories. Right from the outset the d&b audiotechnik approach was to build integrated sound reinforcement systems

that actually are more than the combination of parts: an entirety where each fits all. Every element is tightly specified, precisely aligned and carefully matched to achieve maximum efficiency. For ease of use, all the user-definable parameters are incorporated, allowing the possibility of adjustment, either

directly, via remote control surfaces, or integrated within wider networks. Neutral sound characteristics leave the user all the freedom needed to realize whatever the brief. At the same time d&b offers finance, service and support, a knowledgeable distribution network, education and training as well as technical

information, so the same optimal acoustic result is achieved consistently by every system anywhere, at any time. In reality: the d&b System reality.



The **V-Series** comprises both line array solutions and point source systems; both offer minimal size and weight in combination with outstanding control of dispersion behaviour and convincing high sound pressure levels. With its crystal clear and detailed audio performance, smooth and even frequency response over distance, high dynamic bandwidth and power and headroom capabilities all make the V-Series a good choice for any medium

to large sound reinforcement applications, for any sound genre. The line array system features an integrated rigging system ensuring speedy deployment providing a quick and easily configurable array solution for all intended applications. This flexible system can be used stand-alone, or is the ideal complement to the larger J-Series in terms of sound character, headroom, dispersion and arrayability for outfills, as a centre

cluster or delays. The high output point source loudspeakers are the answer for any sound reinforcement system that demand high sound pressure levels from a single box solution. The V loudspeakers are designed for a wide range of applications with a clear perspective to provide mobile, flexible, configurable solutions to the most arduous sound reinforcement situations. The **Vi loudspeakers** differ only slightly in cabinet construction

and mounting hardware. They are intended for permanently installed performance spaces where the specification is rider driven. Both the Vi cabinets and mounting hardware can be properly colour matched to interior designs and are weather protected for climatically hostile environments.

The V-Series

The 3-way passive **V7P** and **Vi7P** point source loudspeakers produce a constant directivity dispersion of 75° x 40° (h x v) with exceptional vertical constant directivity dispersion control nominally being maintained down to 350 Hz. This is achieved using a symmetrical dipolar driver arrangement for the two 10" LF neodymium drivers, with a centrally mounted horn-loaded 8" MF driver and a coaxial 1.4" exit HF compression driver mounted on a constant directivity horn. The **V10P** and **Vi10P** point source loudspeakers feature the same driver configuration, but produce a wider 110° horizontal dispersion pattern. Both loudspeakers feature a rotatable HF horn which enables deployment in either orientation. The advanced bass reflex and venting design combined with a large cabinet volume increases the LF performance of these compact cabinets, with a frequency response extending from 59 Hz to 18 kHz.



V7P/V10P loudspeaker



Vi7P/Vi10P loudspeaker



V-GSUB

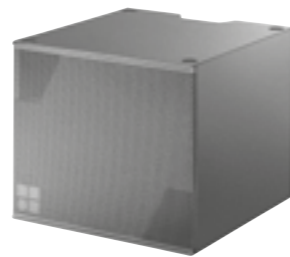

Vi-GSUB



V8/V12 loudspeaker



Vi8/Vi12 loudspeaker



V subwoofer



Vi subwoofer

The **V-GSUB** and **Vi-GSUB** are actively driven cardioid subwoofers that require only one amplifier channel. These subwoofers share the same acoustical and visual design as the V-SUB and Vi-SUB, but are intended for ground stacked applications only.

The **V8** and **Vi8** line array loudspeakers produce an 80° constant directivity dispersion pattern in the horizontal plane. They utilize a passive 3-way design featuring two 10" neodymium LF drivers, one hornloaded 8" MF driver, two 1.4" exit HF compression drivers with 2.5" voicecoils mounted to a dedicated wave shaping device and a passive crossover network.

The **V12** and **Vi12** loudspeakers line array modules, which are acoustically and mechanically compatible with the V8 Loudspeaker and Vi8 Loudspeaker respectively, differ only in the 120° horizontal coverage. All components are arranged symmetrically around the centre axis of the cabinet to produce a perfect symmetrical dispersion pattern. Due to the dipolar arrangement of the LF drivers, a broadband, horizontal dispersion control is maintained down to approximately 250 Hz.

The **V** and **Vi** subwoofers are compact high performance cardioid subwoofers powered by a single amplifier channel. They share the same width as the V8/Vi8 and V12/Vi12 loudspeakers and are equipped with compatible flying fittings. The V and Vi-SUB house two long excursion neodymium drivers in an integrated cardioid setup to avoid unwanted energy behind the system. The Vi cabinets feature an impact resistant paint finish; Weather Resistant and Special Colour options are available.

All V loudspeakers are finished with a PCP (Polyurea Cabinet Protection) coating that provides mobile systems with protection against impact and resistance to the adverse effects on cabinets caused by changing ambient outdoor conditions.

The d&b software offering aids the entire system setup process. The **d&b ArrayCalc simulation software** allows the virtual optimization of loudspeaker line arrays, point source and column loudspeakers as well as subwoofers and their adjustment to venue conditions. The **d&b NoizCalc immission modelling software** uses international standards to model noise immission from d&b loudspeaker systems. NoizCalc takes data from ArrayCalc and calculates the sound propagation towards the far field. The complete system configuration simulated in ArrayCalc is assimilated by the **d&b R1 Remote control software** into an intuitive graphical user interface to manage the amplifiers, and loudspeakers, from anywhere in the venue. The **R90 Touchscreen remote control** provides quick, reliable, and effortless operation of day-to-day functions of a preconfigured d&b system, without needing expert level knowledge of audio.

The planning process using BIM (Building Information Modelling) is supported with Revit files available for all loudspeakers and accessories, creating accurate project data and visualisation.

d&b amplifiers are specifically designed for use with d&b loudspeakers, and are at the heart of the d&b system approach. These devices contain extensive Digital Signal Processing capabilities to provide comprehensive loudspeaker management and specific switchable filter functions to precisely target the system response for a wide variety of applications. The four channel **D40** and **D80** amplifier are intended for mobile applications requiring the highest Sound Pressure Levels. The installation specific four channel **30D** and **40D** amplifiers are intended for permanent integration within venues which require medium to high Sound Pressure Levels. These amplifiers all provide extensive user-definable equalization containing two 16-band equalizers with parametric, notch, shelving and asymmetric filters as well as delay capabilities of up to 10 seconds.

The d&b Audio network bridges interface between audio transport networks and AES3 digital audio signals while also providing distribution of Ethernet control data. The **DS10** supports Dante networks, while the **DS20** is used for the open standards-based Milan protocol.

The **DS100 Signal Engine** is based on a specialized rack mount 3 RU audio processor with Audinate Dante networking. It provides a 64 x 64 audio matrix with level and delay adjustments at all cross points. Additional software modules provide dynamic source positioning and emulated acoustics functions.



R90 Touchscreen remote control



D80 amplifier



D40 amplifier



30D amplifier



40D amplifier



DS10 Audio network bridge



DS20 Audio network bridge



DS100 Signal Engine

The V7P loudspeaker

The Vi7P loudspeaker

V7P/Vi7P loudspeaker

The 3-way passive V7P and Vi7P loudspeakers feature two 10" drivers in a dipole arrangement with a horn loaded 8" MF driver and a 1.4" exit compression driver mounted onto a rotatable CD horn. The Vi7P is the installation version of the V7P loudspeaker and differs only in cabinet construction, finish and mounting hardware. The innovative horn design for the centrally mounted 8" MF driver produces a remarkable sensitivity resulting in an exceptional performance in the vocal range. An advanced bass-reflex and venting design delivers an extended LF output with full bandwidth capabilities.

These high performance point source loudspeakers provide a broad variety of deployment possibilities, especially when used as a stand-alone full range system, or combined with other elements from the V-Series, either ground stacked or flown. The HF horn can be rotated by 90° to enable horizontal orientation. The loudspeaker cabinets are constructed from marine plywood, the V7P has an impact and weather protected PCP (Polyurea Cabinet Protection) finish, while the Vi7P has an impact resistant paint finish. The front of the loudspeaker cabinets are protected by a rigid metal grill. The V7P cabinet incorporates a pair of handles. M10 threaded inserts are provided for attaching d&b rigging hardware.

System data

Frequency response (-5 dB standard) 59 Hz - 18 kHz
 Frequency response (-5 dB CUT mode)..... 100 Hz - 18 kHz
 Max. sound pressure (1 m, free field)¹
 with 30D/D20 137 dB
 with D40/40D³ 140 dB
 with D80 140 dB

Loudspeaker data

Nominal impedance 8 ohms
 Power handling capacity (RMS/peak 10 ms) 500/2000 W
 Nominal dispersion angle (h x v) 75° x 40°
 Components 2 x 10" driver with neodymium magnet
 1 x 8" driver with neodymium magnet
 1 x 1.4" exit compression driver
 passive crossover network
 Connections V7P 2 x NLT4 F/M
 optional 2 x NL4
 Connections Vi7P 2 x NL4 and screw terminal block
 Weight V7P/Vi7P 33 kg (75 lb)

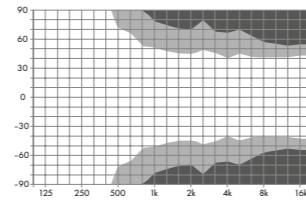

V7P and Vi7P horizontal dispersion characteristics²

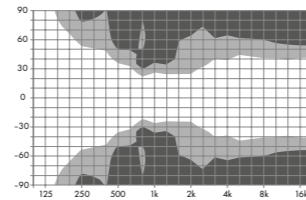

V7P and Vi7P horizontal dispersion characteristics/horizontal setup, horn rotated²

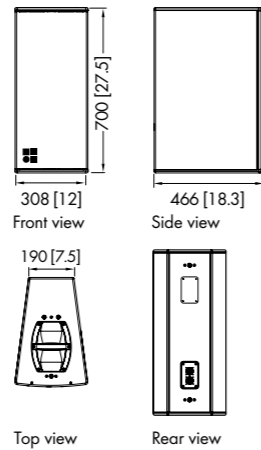

V7P cabinet dimensions in mm [inch]

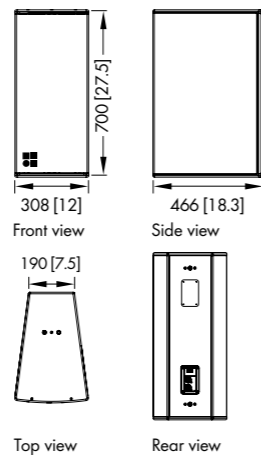

Vi7P cabinet dimensions in mm [inch]

¹ Broadband measurement, pink noise, crest factor 4, peak measurement, linear weighting
² Dispersion angle vs frequency plotted using lines of equal sound pressure (isobars) at -6 dB and -12 dB
³ 1 loudspeaker per channel

The V10P loudspeaker

The Vi10P loudspeaker

V10P/Vi10P loudspeaker

The 3-way passive V10P and Vi10P loudspeakers feature two 10" drivers in a dipole arrangement with a horn loaded 8" MF driver and a 1.4" exit compression driver mounted onto a rotatable CD horn. The Vi10P is the installation version of the V10P loudspeaker and differs only in cabinet construction, finish and mounting hardware. The innovative horn design for the centrally mounted 8" MF driver produces a remarkable sensitivity resulting in an exceptional performance in the vocal range. An advanced bass-reflex and venting design delivers an extended LF output with full bandwidth capabilities.

These high performance point source loudspeakers provide a broad variety of deployment possibilities, especially when used as a stand-alone full range system, or combined with other elements from the V-Series, either ground stacked or flown. The HF horn can be rotated by 90° to enable horizontal orientation. The loudspeaker cabinets are constructed from marine plywood, the V10P has an impact and weather protected PCP (Polyurea Cabinet Protection) finish, while the Vi10P has an impact resistant paint finish. The front of the loudspeaker cabinets are protected by a rigid metal grill. The V10P cabinet incorporates a pair of handles. M10 threaded inserts are provided for attaching d&b rigging hardware.

System data

Frequency response (-5 dB standard) 59 Hz - 18 kHz
 Frequency response (-5 dB CUT mode)..... 100 Hz - 18 kHz
 Max. sound pressure (1 m, free field)¹
 with 30D/D20 136 dB
 with D40/40D³ 139 dB
 with D80 139 dB

Loudspeaker data

Nominal impedance 8 ohms
 Power handling capacity (RMS/peak 10 ms) 500/2000 W
 Nominal dispersion angle (h x v) 110° x 40°
 Components 2 x 10" driver with neodymium magnet
 1 x 8" driver with neodymium magnet
 1 x 1.4" exit compression driver
 passive crossover network
 Connections V10P 2 x NLT4 F/M
 optional 2 x NL4
 Connections Vi10P 2 x NL4 and screw terminal block
 Weight V10P/Vi10P 33 kg (75 lb)

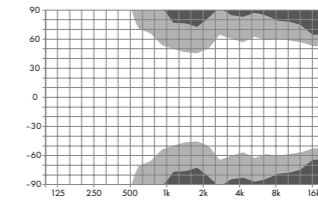

V10P and Vi10P horizontal dispersion characteristics²

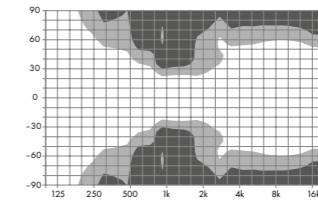

V10P and Vi10P horizontal dispersion characteristics/horizontal setup, horn rotated²

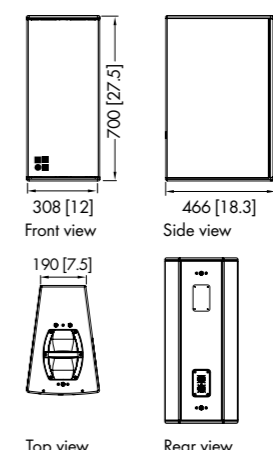

V10P cabinet dimensions in mm [inch]

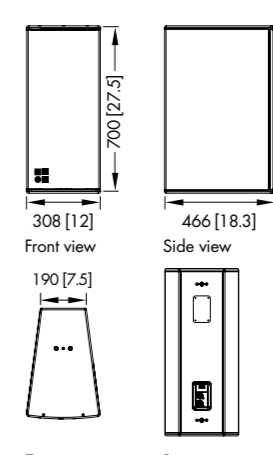

Vi10P cabinet dimensions in mm [inch]

¹ Broadband measurement, pink noise, crest factor 4, peak measurement, linear weighting
² Dispersion angle vs frequency plotted using lines of equal sound pressure (isobars) at -6 dB and -12 dB
³ 1 loudspeaker per channel

The V-GSUB The Vi-GSUB

The V7P, V10P and V-GSUB transport accessories

V-GSUB/Vi-GSUB

The V-GSUB and Vi-GSUB are actively driven high performance cardioid subwoofers powered by a single amplifier channel. The V-GSUB and Vi-GSUB are intended for ground stacked applications only, and share the same acoustical and visual design as the V-SUB and Vi-SUB, which feature integrated rigging equipment. The Vi-GSUB is the installation version of the V-GSUB. They house two long excursion neodymium drivers, an 18" driver in a bass-reflex design facing to the front and a 12" driver in a two chamber bandpass design radiating to the rear. The cardioid dispersion pattern resulting from this arrangement avoids unwanted energy behind the system that reduces the excitation of the reverberant field at low frequencies and provides the greatest accuracy of low frequency reproduction.

The cabinet is constructed from marine plywood and has an impact and weather protected PCP (Polyurea Cabinet Protection) finish. The front of the loudspeaker cabinet is protected by a rigid metal grill backed by an acoustically transparent foam. The V-GSUB top panel has a recess in the form of the footprint of a V7P/V10P enclosure to prevent cabinet movement when stacking one TOP loudspeaker. The enclosure features two runners to protect the bottom panel from scratching. Two correspondingly shaped recesses are incorporated into the top panel of each V-GSUB cabinet to accept these runners, preventing cabinet movement when stacked. Each side of the V-GSUB panel incorporates two handles whilst the top panel has an M20 high stand flange inserted.

System data

Frequency response (-5 dB standard)	37 Hz - 115 Hz
Frequency response (-5 dB 100 Hz mode).....	37 Hz - 95 Hz
Max. sound pressure (1 m, free field) ¹	
with 30D/D20.....	133 dB
with D40/40D ²	137 dB
with D80	137 dB

Loudspeaker data

Nominal impedance.....	8 ohms
Power handling capacity (RMS/peak 10 msec)	800/3200 W
Components.....	1 x 18" driver
.....	1 x 12" driver
Connections V-GSUB.....	2 x NL4 F/M
.....	optional 2 x NL4
Connections Vi-GSUB.....	2 x NL4 and screw terminal block

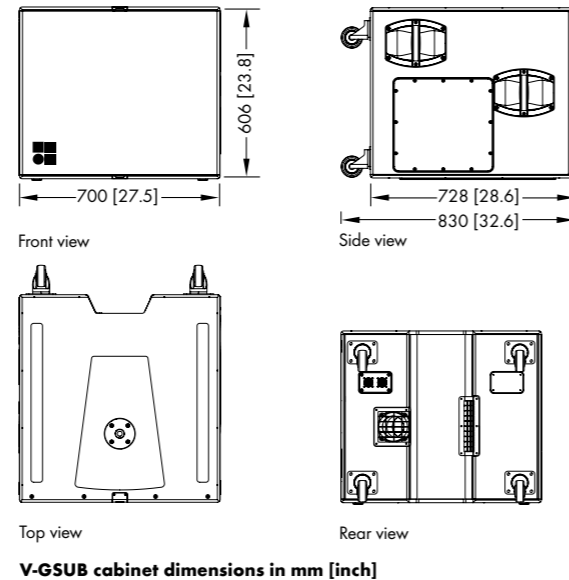

V-GSUB cabinet dimensions in mm [inch]

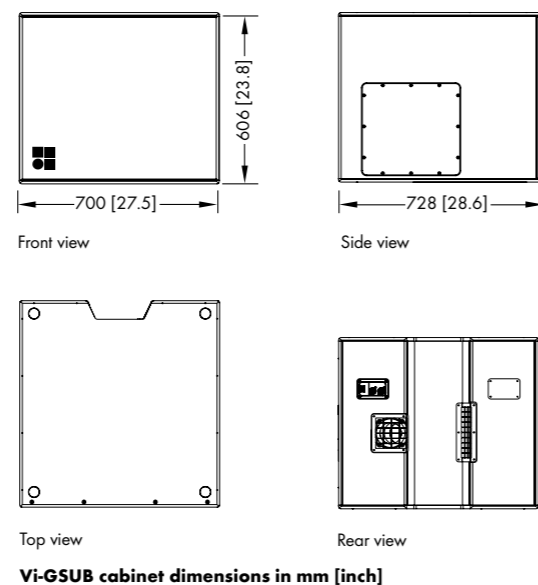

Vi-GSUB cabinet dimensions in mm [inch]

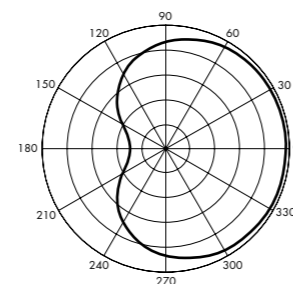

Cardioid polar pattern

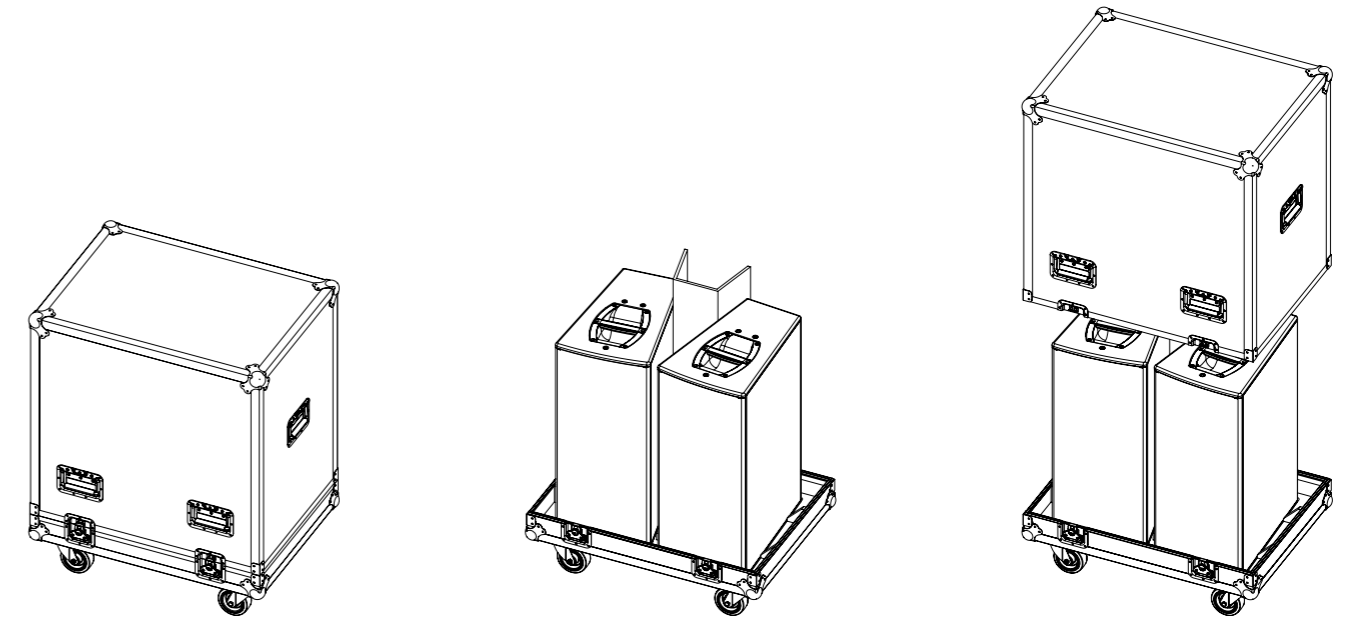

E7466
Touring case 2 x V7P/V10P
Dimensions (H x W x D):
970 x 800 x 600 mm
38.2 x 31.5 x 23.6 inch
Net weight: 43 kg (94.8 lb)

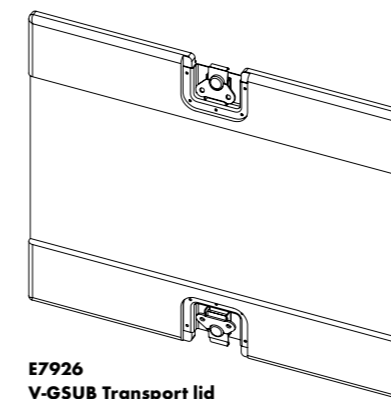

E7926
V-GSUB Transport lid

¹ Broadband measurement, pink noise, crest factor 4, peak measurement, linear weighting
² 1 subwoofer per channel

The V8 loudspeaker

The Vi8 loudspeaker

V8/Vi8 loudspeaker

The V8 and Vi8 are line array loudspeakers, the Vi8 Loudspeaker is the installation version of the V8 Loudspeaker. They are 3-way passive designs featuring two 10" LF drivers, one hornloaded 8" MF driver and two 1.4" exit HF compression drivers with 2.5" voicecoils mounted to a dedicated waveshaping device. The symmetrical dipolar arrangement of the neodymium LF drivers around the centrally mounted coaxial MF and HF components allows a smooth overlap of the adjacent frequency bands in the crossover design. This results in an exceptional 80° horizontal constant directivity dispersion control nominally being maintained down to 250 Hz.

The mechanical and acoustical design enables flown vertical arrays of up to twenty four loudspeakers to be suspended using vertical splay angles between 0° to 14° with a 1° resolution. It can be used in columns of purely V8 or Vi8 loudspeakers or combined with V12/Vi12s and/or with V-SUB/Vi-SUBs.

The cabinet is constructed from marine plywood and has an impact and weather protected PCP (Polyurea Cabinet Protection) finish. The front of the loudspeaker cabinet is protected by a rigid metal grill backed by an acoustically transparent foam. Each side panel of the V8 cabinet incorporates a handle while two additional recessed grips are provided at the rear bottom of both the V8 and Vi8.

System data

Frequency response (-5 dB standard) 67 Hz - 18 kHz
 Frequency response (-5 dB CUT mode)..... 100 Hz - 18 kHz
 Max. sound pressure (1 m, free field)¹
 with 30D/D20..... 139 dB
 with D40/40D³ 142 dB
 with D80 142 dB

Loudspeaker data

Nominal impedance 8 ohms
 Power handling capacity (RMS/peak 10 msec) 500/2000 W
 Nominal dispersion angle (horizontal) 80°
 Splay angle settings 0° - 14°
 1° increment
 Components 2 x 10" driver
 1 x 8" driver
 2 x 1.4" exit compression driver
 passive crossover network
 Connections V8 2 x NLT4 F/M
 optional 2 x NL4
 Connections Vi8 2 x NL4
 Weight 34 kg (75 lb)

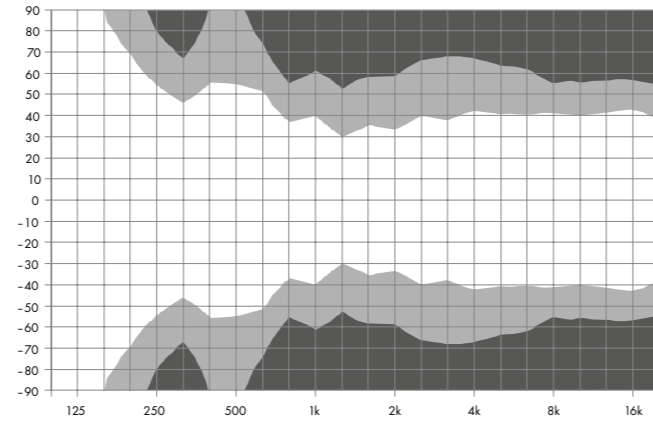

V8 and Vi8 horizontal dispersion characteristics²

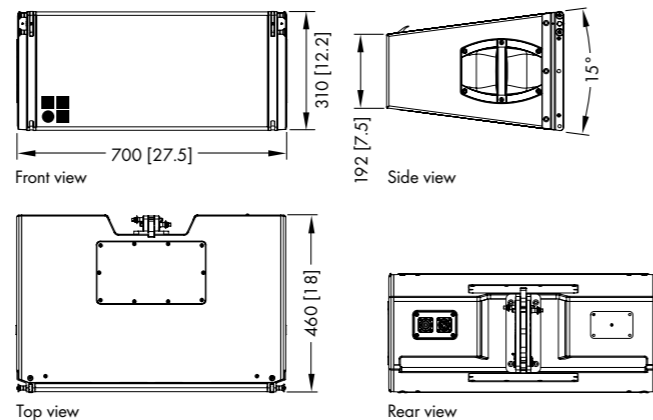

V8 cabinet dimensions in mm [inch]

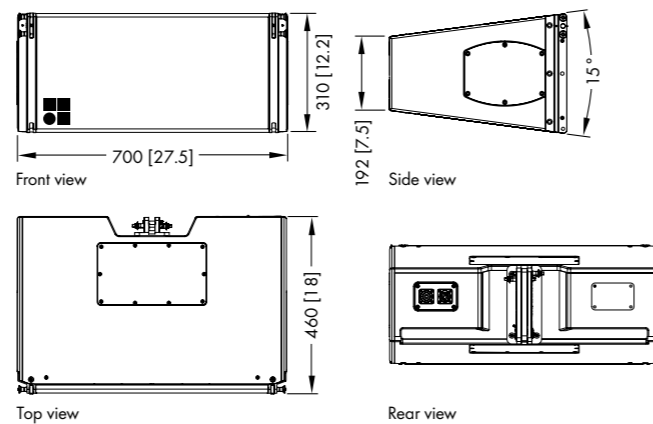

Vi8 cabinet dimensions in mm [inch]

¹ Broadband measurement, pink noise, crest factor 4, peak measurement, linear weighting
² Dispersion angle vs frequency plotted using lines of equal sound pressure (isobars) at -6 dB and -12 dB
³ 1 loudspeaker per channel

The V12 loudspeaker

The Vi12 loudspeaker

V12/Vi12 loudspeaker

The V12 and Vi12 are line array loudspeakers, the Vi12 loudspeaker is the installation version of the V12 loudspeaker. They are 3-way passive designs featuring two 10" LF drivers, one hornloaded 8" MF driver and two 1.4" exit HF compression drivers with 2.5" voicecoils mounted to a dedicated waveshaping device. The symmetrical dipolar arrangement of the neodymium LF drivers around the centrally mounted coaxial MF and HF components allows a smooth overlap of the adjacent frequency bands in the crossover design. This results in an exceptional 120° horizontal constant directivity dispersion control nominally being maintained down to 250 Hz.

The mechanical and acoustical design enables flown vertical arrays of up to twenty four loudspeakers to be suspended using vertical splay angles between them of 0° to 14° with a 1° resolution. It can be used in columns of purely V12 or Vi12 loudspeakers or combined with V8/Vi8s and/or with V-SUB/Vi-SUBs.

The cabinet is constructed from marine plywood and has an impact and weather protected PCP (Polyurea Cabinet Protection) finish. The front of the loudspeaker cabinet is protected by a rigid metal grill backed by an acoustically transparent foam. Each side panel of the V12 cabinet incorporates a handle while two additional recessed grips are provided at the rear bottom of both the V12 and Vi12.

System data

Frequency response (-5 dB standard) 67 Hz - 18 kHz
 Frequency response (-5 dB CUT mode)..... 100 Hz - 18 kHz
 Max. sound pressure (1 m, free field)¹
 with 30D/D20..... 139 dB
 with D40/40D³ 142 dB
 with D80 142 dB

Loudspeaker data

Nominal impedance 8 ohms
 Power handling capacity (RMS/peak 10 msec) 500/2000 W
 Nominal dispersion angle (horizontal) 120°
 Splay angle settings 0° - 14°
 1° increment
 Components 2 x 10" driver
 1 x 8" driver
 2 x 1.4" exit compression driver
 passive crossover network
 Connections V12 2 x NLT4 F/M
 optional 2 x NL4
 Connections Vi12 2 x NL4
 Weight 34 kg (75 lb)

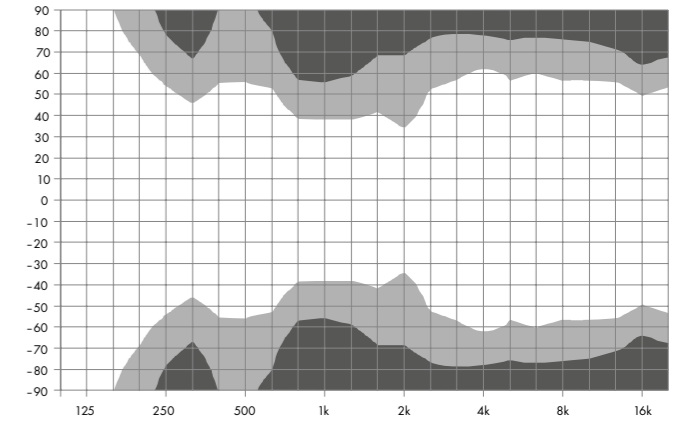

V12 and Vi12 horizontal dispersion characteristics²

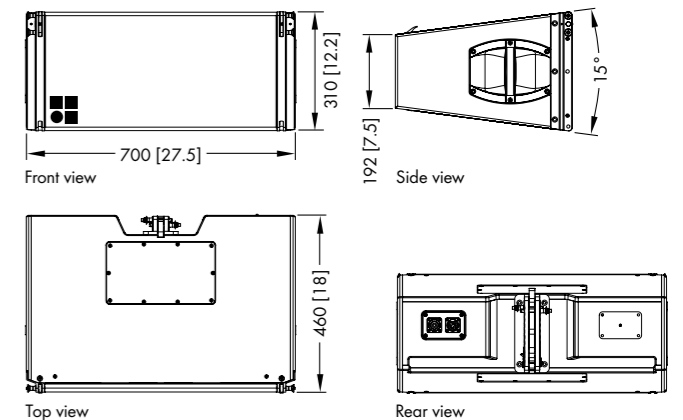

V12 cabinet dimensions in mm [inch]

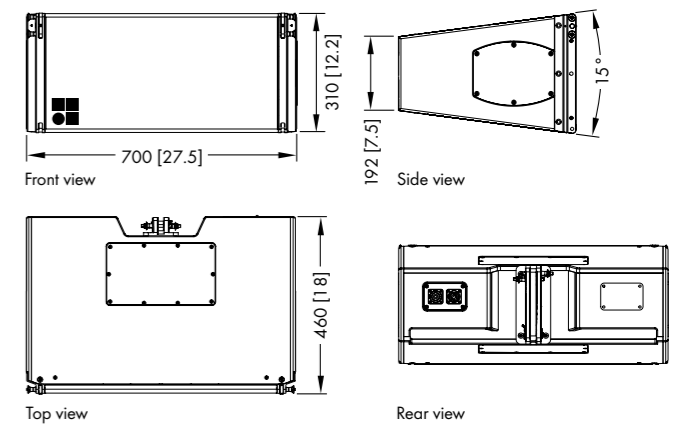

Vi12 cabinet dimensions in mm [inch]

¹ Broadband measurement, pink noise, crest factor 4, peak measurement, linear weighting
² Dispersion angle vs frequency plotted using lines of equal sound pressure (isobars) at -6 dB and -12 dB
³ 1 loudspeaker per channel

The V subwoofer

The Vi subwoofer

The Vi Weather Resistant, Special Colour and Custom solutions options

V/Vi subwoofer

The V-SUB/Vi-SUB are actively driven high performance cardioid subwoofers powered by a single amplifier channel. The V-SUB and Vi-SUB feature integrated rigging equipment, and share the same acoustical and visual design as the V-GSUB and Vi-GSUB, which are intended for ground stacked applications only. The Vi-SUB is the installation version of the V-SUB. They house two long excursion neodymium drivers, an 18" driver in a bass-reflex design facing to the front and a 12" driver in a two chamber bandpass design radiating to the rear. The cardioid dispersion pattern resulting from this arrangement avoids unwanted energy behind the system that reduces the excitation of the reverberant field at low frequencies and provides the greatest accuracy of low frequency reproduction.

The V-SUB and Vi-SUB can be used to supplement V8/Vi8 and V12/Vi12 loudspeakers in various combinations, ground stacked or flown, either integrated on top of a V8/V12 or Vi8/Vi12 array or as a separate column.

The cabinet is constructed from marine plywood and has an impact and weather protected PCP (Polyurea Cabinet Protection) finish. The front of the loudspeaker cabinet is protected by a rigid metal grill backed by an acoustically transparent foam. Each side of the V subwoofer panel incorporates two handles whilst the top panel has an M20 high stand flange inserted.

System data

Frequency response (-5 dB standard).....	37 - 115 Hz
Frequency response (-5 dB 100 Hz mode).....	37 - 95 Hz
Max. sound pressure (1 m, free field) ¹	
with 30D/D20.....	133 dB
with D40/40D ²	137 dB
with D80	137 dB

Loudspeaker data

Nominal impedance.....	8 ohms
Power handling capacity (RMS/peak 10 msec)	800/3200 W
Splay angle settings	0° and 2.5°
Components.....	1 x 18" driver
.....	1 x 12" driver
Connections V-SUB.....	2 x NLT4 F/M
.....	optional 2 x NL4
Connections Vi-SUB.....	2 x NL4
Weight V-SUB/Vi-SUB.....	64/62 kg (141/137 lb)

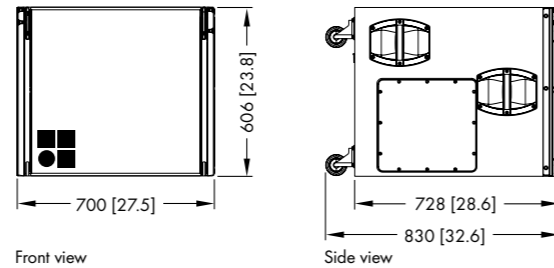

Front view

Side view

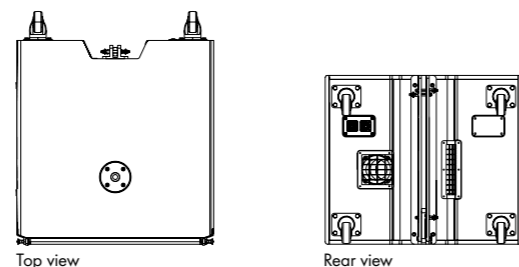

Top view

Rear view

V-SUB cabinet dimensions in mm [inch]

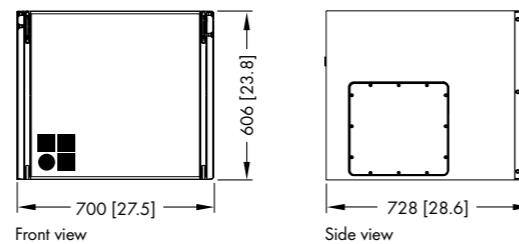

Front view

Side view

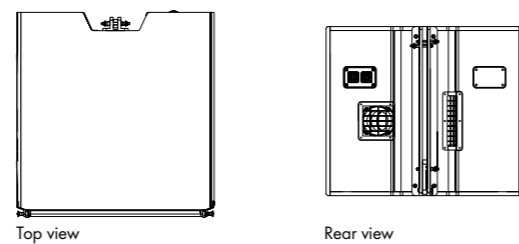

Top view

Rear view

Vi-SUB cabinet dimensions in mm [inch]

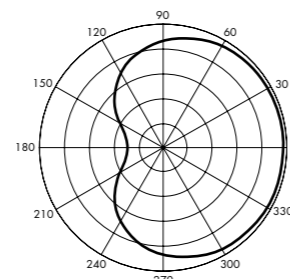

Cardioid polar pattern

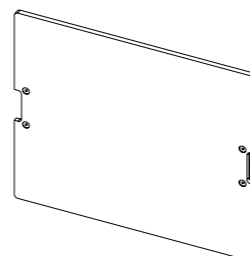

E7923 V-SUB Wooden lid

Weather Resistant (WR) option

The WR option provides an IP54 rating, and enables operation of loudspeakers in changing ambient conditions, with some loudspeakers able to achieve an IP55 rating. However it is not intended to enable permanent, unprotected operation of loudspeakers outdoors. Cabinets used outdoors even with the WR option should always be aimed either horizontally or with a downward tilt. All WR speakers will be delivered without a cable. An optional WR cable (Z5763.000 - H07-RN-F 2 x 2.5 mm²/AWG 13, Faston connector type 2 x 6.3 mm male) with a standard length of 5.5 m is available. Other length on request.

Special Colour (SC) option

The paint finish of all loudspeaker cabinets and most accessories can be executed in almost any custom colour in accordance with common colour tables. All rigging fittings at the rear of the cabinet, Front links and Locking pins remain in black. Other paint finishes such as metallic are available on request. The acoustically transparent foam fitted behind the rigid metal grill is also painted with the requested special colour.

Custom solutions (SVS and SWR) option

SVS (Variants For Stadiums) loudspeakers have no integral rigging components, but instead, have threaded inserts in their side panels. The cabinets will be mechanically supported by metal brackets specifically designed for the respective application by Custom solutions. SWR (Sea Water Resistant) loudspeaker models are based on WR or SVS variants where available, and withstand outdoor operation in wet and acid or salty environments like on cruise ships or coastal locations. Other custom solutions are available upon request.

The V7P/Vi7P, V10P/Vi10P and V-GSUB/Vi-GSUB mounting accessories

Safety approval

d&b loudspeakers and accessories are designed for setup and use within situations requiring compliance with the provisions and directives of the DGUV regulation 17 (formerly BGV C1).

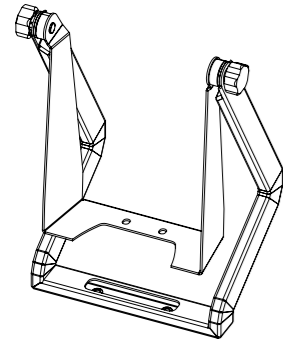

Z5383
VP Mounting bracket

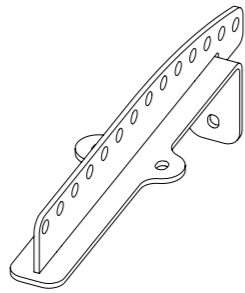

Z5384
VP Flying adapter

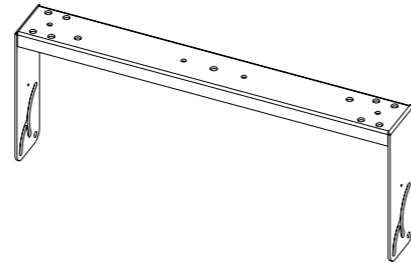

Z5388
VP Horizontal bracket



Z5550
M20 Stand adapter

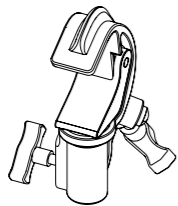

Z5012
Pipe clamp for TV spigot
For a tube diameter up to
70 mm/2.75"

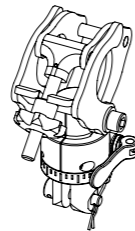

Z5147
Rota clamp
WLL: 500 kg (1100 lb)
for a tube diameter up
to 51 mm/2"



Z5049
Flying pin 8mm¹

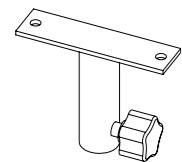

Z5024
Loudspeaker stand adapter

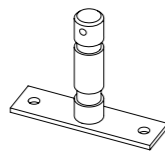

Z5010
TV Spigot with fixing plate

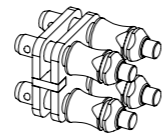

Z5551
VP Flying adapter link

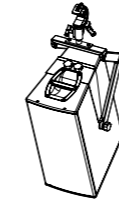

V7P/V10P with
Z5383 VP Mounting bracket
Z5010 TV Spigot with fixing plate
Z5012 Pipe clamp

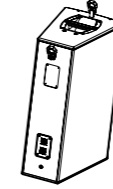

V7P/V10P¹ with
Z5049 Flying pin 8mm

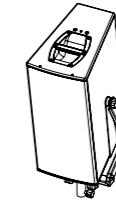

V7P/V10P with
Z5383 VP Mounting bracket
Z5010 TV Spigot with fixing plate
Z5024 Loudspeaker
stand adapter

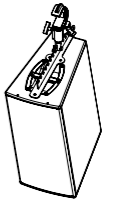

V7P/V10P with
Z5384 VP Flying adapter
Z5015 TV Spigot for
flying adapter 02
Z5012 Pipe clamp

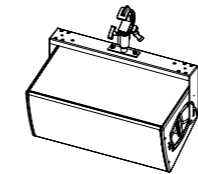

V7P/V10P with
Z5388 VP Horizontal bracket
Z5010 TV Spigot with fixing plate
Z5012 Pipe clamp

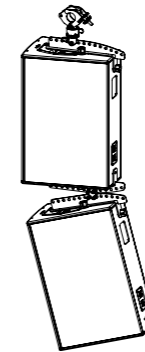

V7P/V10P with
Z5384 VP Flying adapter
Z5147 Rota clamp
Z5551 VP Flying adapter link

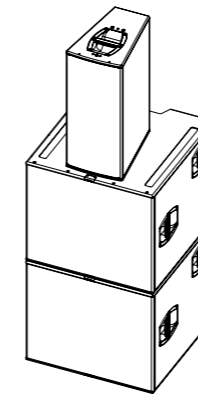

V7P/V10P with V-GSUB

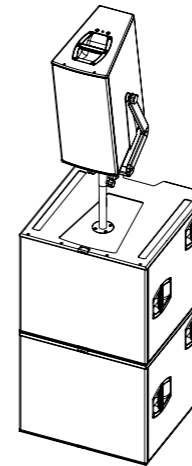

V7P/V10P with
Z5550 M20 Stand adapter

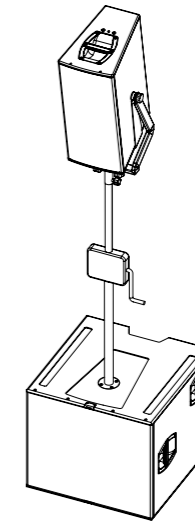

V7P/V10P with
Z5383 VP Mounting bracket
Z5024 Loudspeaker
stand adapter
Z5013 M20 pole with winder

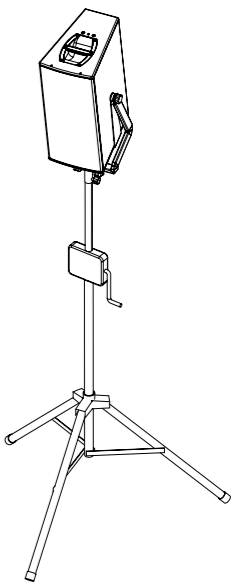

V7P/V10P with
Z5383 VP Mounting bracket
Z5024 Loudspeaker
stand adapter
Z5009 Loudspeaker
stand with winder

The V8, V12 and V-SUB rigging accessories

The V8, V12 and V-SUB rigging examples

Safety approval

d&b loudspeakers and accessories are designed for setup and use within situations requiring compliance with the provisions and directives of the DGUV regulation 17 (formerly BGV C1).

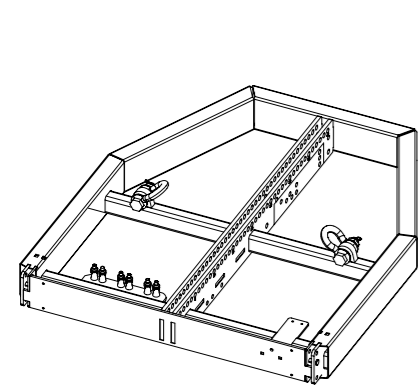

Z5380
V Flying frame
For a maximum of twenty four V8/V12 loudspeakers or fourteen V subwoofers

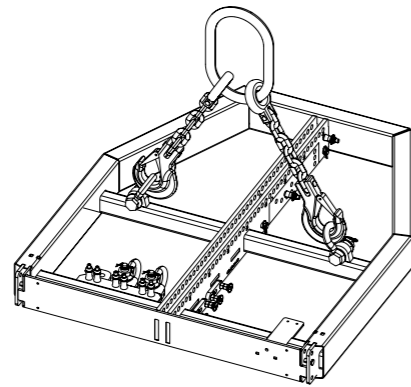

Z5380
V Flying frame
Supplied with
1 x Z5775 Safety chainset
2 x V Load adapter
1 x V Load adapter for Rota clamp
2 x Front link

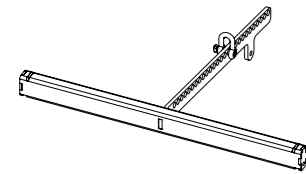

Z5385
V Flying adapter
For a maximum of four V8/V12 loudspeakers; supplied with 1t Shackle



Z5775
Safety chainset 2t



Z5776
Hoist connector chain

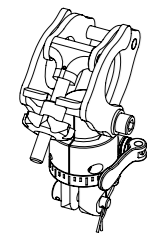

Z5147
Rota clamp
WLL: 500 kg (1100 lb)
for a tube diameter up to 51 mm/2"

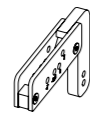

Z5386
V Stack adapter

These rigging examples are for illustration only. For further information please refer to the TI 385 d&b Line array design as well as the V-Series Rigging manual, both of which are available for download at www.dbaudio.com.

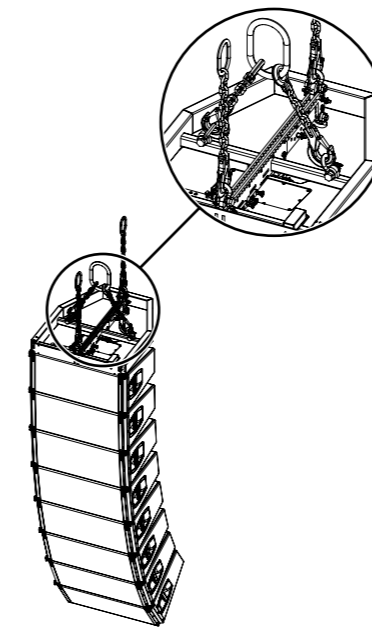

V8/V12 array with Z5380 V Flying frame
2 x Z5776 Hoist connector chain
Z5775 Safety chainset

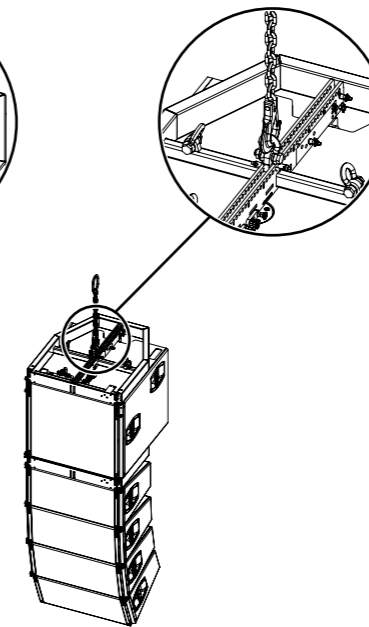

V-Series mixed array with Z5380 V Flying frame
Z5776 Hoist connector chain

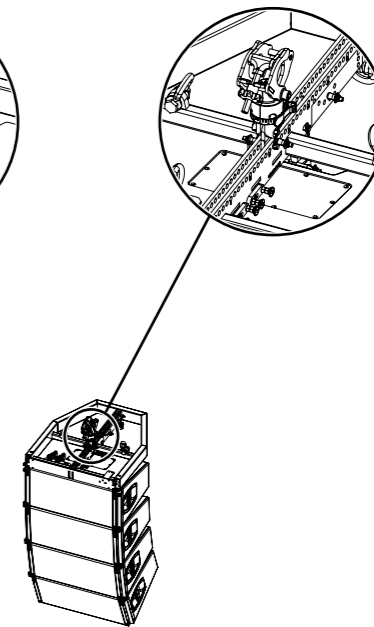

V8/V12 array with Z5380 V Flying frame
Z5147 Rota clamp

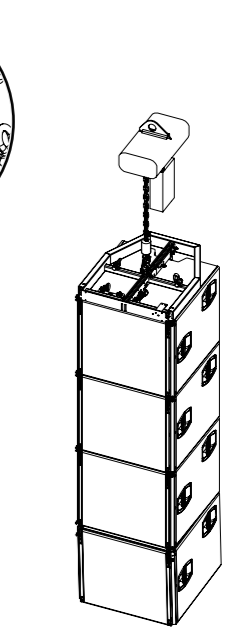

V-SUB column with Z5380 V Flying frame

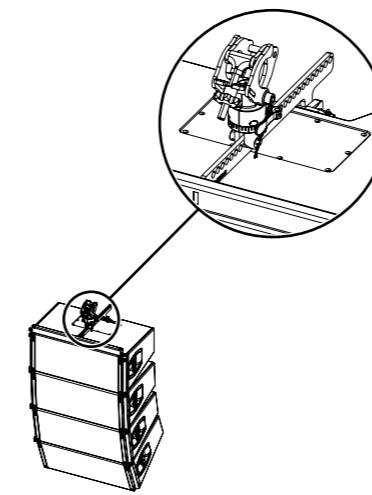

V8/V12 array with Z5385 V Flying adapter
Z5147 Rota clamp

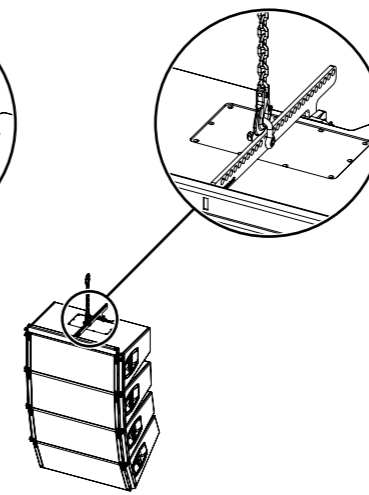

V8/V12 array with Z5385 V Flying adapter
E6507 1t Shackle

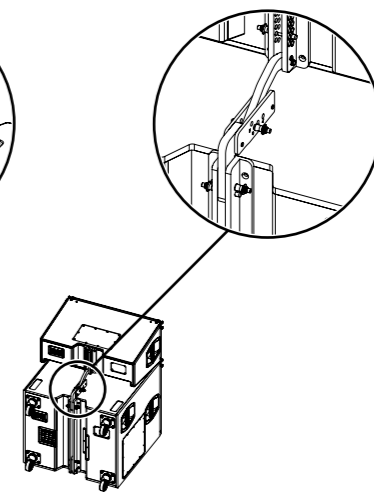

V-Series ground stack with Z5386 V Stack adapter

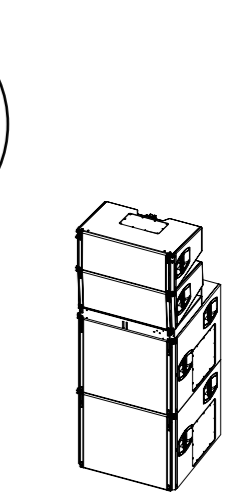

V-Series ground stack with Z5380 V Flying frame

The Vi8, Vi12 and Vi-SUB rigging accessories and examples

The V8, V12 and V Flying frame cases and carts

Safety approval

d&b loudspeakers and accessories are designed for setup and use within situations requiring compliance with the provisions and directives of the DGUV regulation 17 (formerly BGV C1).

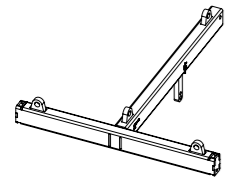

Z5387.000
Vi Mounting frame top
For a maximum load equivalent to four Vi8/Vi12 loudspeakers
136 kg (300 lb)

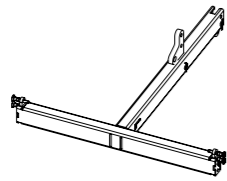

Z5387.001
Vi Mounting frame bottom

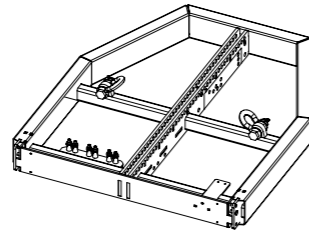

Z5380
V Flying frame
For a maximum of twenty four V8/V12/Vi8/Vi12 loudspeakers or fourteen V/Vi subwoofers

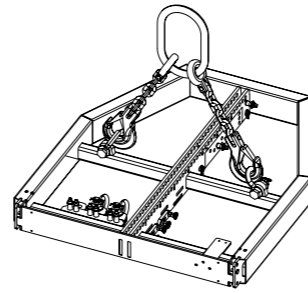

Z5380
V Flying frame
Supplied with
1 x 5775 Safety chainset
2 x V Load adapter
1 x V Load adapter for Rota clamp
2 x Front link

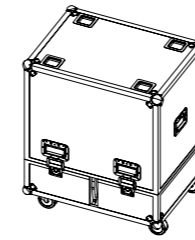

E7462
Touring case 2 x V8/V12
Dimensions (H x W x D):
900 x 800 x 600 mm
35.4 x 31.5 x 23.6 inch
Net weight: 40 kg (88 lb)

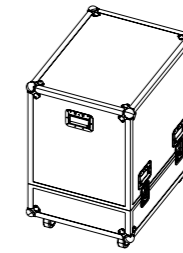
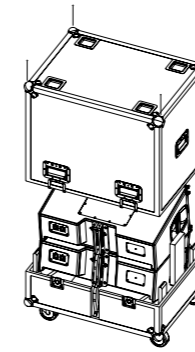

E7465
Touring case 2 x V Flying frame
Dimensions (H x W x D):
970 x 800 x 600 mm
38.2 x 31.5 x 23.6 inch
Net weight: 52 kg (120 lb)

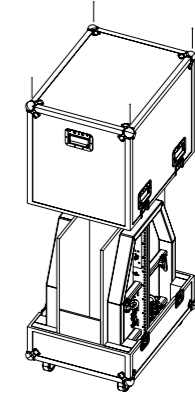

E6507
1t Shackle



Z5776
Hoist connector chain



Z5775
Safety chainset 2t

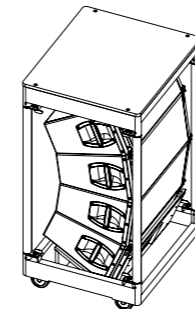

E7463
Touring cart 4 x V8/V12
Dimensions (H x W x D):
1420 x 700 x 800 mm
56 x 27.5 x 31.5 inch
Total weight: 190 kg (420 lb)
Maximum top load: 100 kg (220 lb)

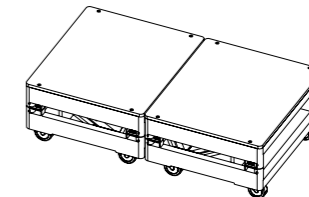
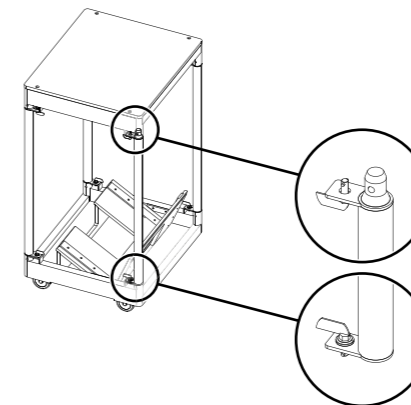

E7464
Touring cart 8 x V8/V12
Dimensions (H x W x D):
1420 x 1400 x 800 mm
56 x 55 x 31.5 inch
Total weight: 360 kg (800 lb)
Maximum top load: 200 kg (440 lb)

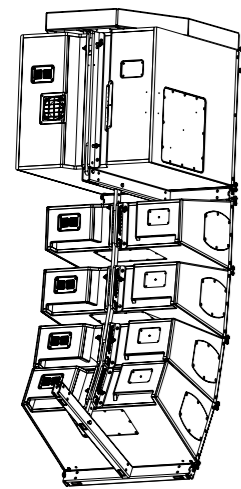
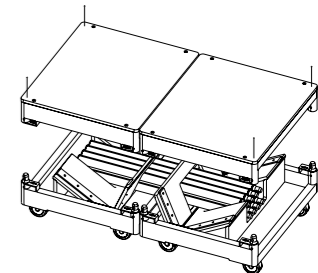

Vi array with
Z5380
V Flying frame
Z5387.001
Vi Mounting frame bottom (2pcs)

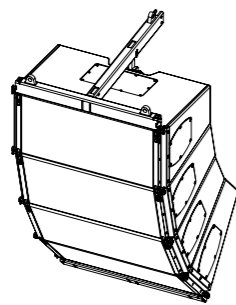

Vi8/Vi12 array with
Z5380
Vi Mounting frame top

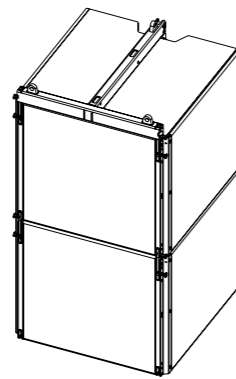

Vi-SUB column with
Z5387.000
Vi Mounting frame top

The d&b ArrayCalc simulation software

The d&b ArrayCalc simulation software is the prediction tool for d&b line arrays, column and point source loudspeakers as well as subwoofers. This is a comprehensive toolbox for all tasks associated with acoustic design, performance prediction, alignment, rigging and safety parameters. For safety reasons d&b line arrays must be designed using the d&b ArrayCalc simulation software. ArrayCalc is available as a native stand-alone application for both Microsoft Windows¹ (Win7 64-bit or later) and Mac OS X² (10.12 or later) operating systems. In combination with the d&b Remote Network, this can significantly reduce setup and tuning time in mobile applications and allows for precise simulations when planning installations. Listening planes can be defined in the venue tab, creating a three dimensional representation of any audience area in a given venue. This can also include balconies, side stalls, arenas, in the round scenarios or festivals. Special functions assist in obtaining accurate dimensions with laser distance finders and inclinometers.

Simulation

Up to forty flown arrays or subwoofer columns can be defined in a project file as single hangs or in pairs. A selection of d&b point source loudspeakers can also be fully integrated as well as a ground stacked SUB array consisting of up to eighty positions. All can be freely positioned according to their intended application, for example as main hang, outfill, nearfill or delay. Position, orientation, aiming and coverage details are displayed. Level over distance is calculated for each source with high resolution in real time, for either band limited or broadband input signals. The comprehensive simulation precisely models the actual performance of the system, taking into account input level, all system configuration options (such as CUT, CPL, HFC or INFRA), limiter headroom and air absorption. Acoustic obstacles, such as video screens, can be added to a model. Acoustic shadowing, whether by these obstacles, or a balcony overhang, is taken into consideration. The load status of all array rigging components is calculated accurately and displayed to determine whether a given array is within the load tolerance. Subwoofer array design is assisted by coverage and polar plot prediction. A specialized algorithm allows the user to specify subwoofer positions and a coverage angle, which is then converted into appropriate delay settings that result in the desired dispersion. The alignment tab enables different sources to be time aligned to one another, as well as showing arrival times and Sound Pressure Levels at a definable reference point on one of the audience areas. For alignment of the flown system with the ground stacked SUB array, the phase response of both the SUB array and a flown source is calculated at a definable reference point.

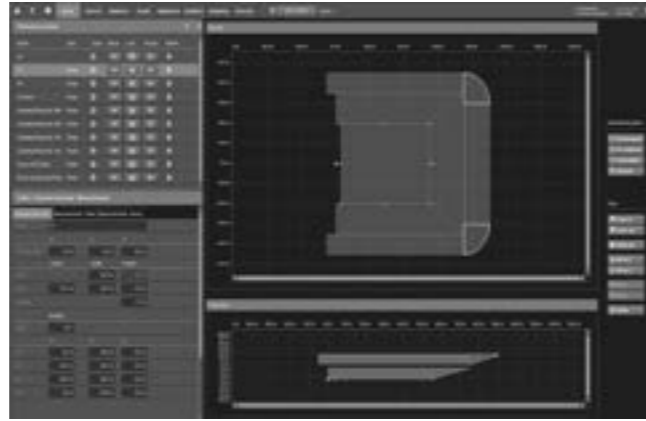

Venue

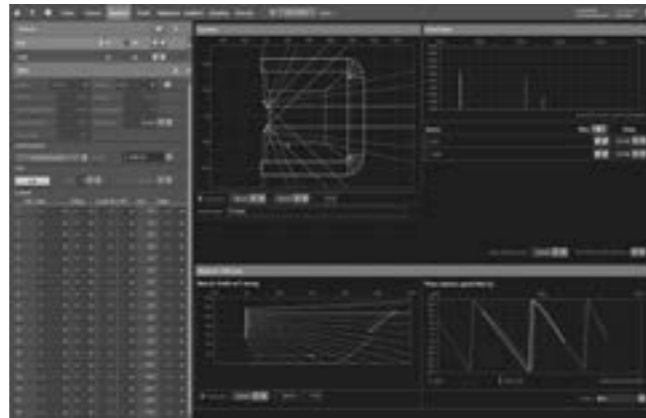

Alignment

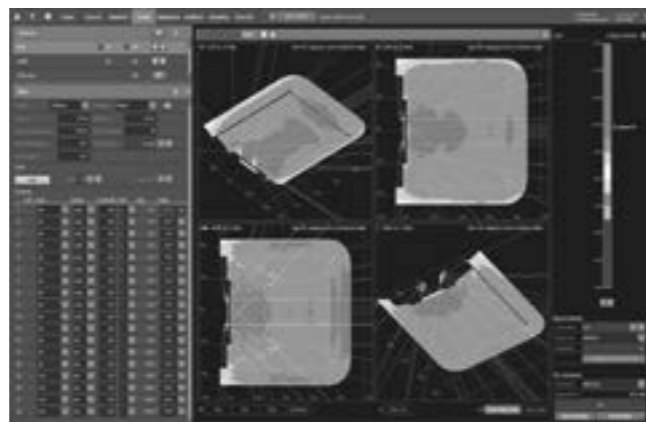

3D Plot quad

Both simulations reflect changes in delay time to the single sources in real time. The d&b ArrayCalc simulation software is available at www.dbaudio.com.

Prediction

The level distribution resulting from the interaction of all active sources can be mapped onto the audience areas in a three-dimensional view, which can also be zoomed, rotated and exported as a graphics file. EASE and DXF data export capabilities are also available. A rigging plot with all necessary coordinates, dimensions and weights of arrays is generated for export and printing and a parts list, detailing all components required. The d&b ArrayCalc Viewer app presents this key information for positioning and flying a d&b audiotechnik loudspeaker system on a mobile device. Once the system has been designed, calculated and optimized, all relevant project information can be shared via email, AirDrop, or downloaded onto any iOS or Android device.

ArrayProcessing

The optional ArrayProcessing function applies powerful filter algorithms to optimize the tonal (spectral) and level (spatial) performance of a line array column over the audience area defined by its mechanical vertical coverage angle. Temperature and Humidity Control (THC) for ArrayProcessing introduces a workflow that permits a system to adapt to changing atmospheric conditions in real time via R1. Within the d&b ArrayCalc simulation software, spectral and level performance targets over the listening areas can be defined while specific level drops or offsets can be applied to certain areas, to assign reduced level zones. ArrayProcessing applies a combination of FIR and IIR filters to each individual cabinet in an array to achieve the targeted performance, with an additional latency of only 5.9 ms. This significantly improves the linearity of the response over distance as well as seamlessly correcting for air absorption. In addition, ArrayProcessing employs the same frequency response targets for all d&b line arrays, to ensure all systems share a common tonality. The resulting coverage is enhanced with spectral consistency and defined level distribution, achieving more linear dispersion and total system directivity to cover longer distances or steep listening areas effectively.

R1 Remote Control Software

R1 uses the same project file created by ArrayCalc and generates an intuitive graphical user interface including complete details of the simulated system, loudspeakers, amplifiers, remote IDs, groups, ArrayProcessing data and all configuration information. This workflow removes the need to manually transfer data from one software program to the other.

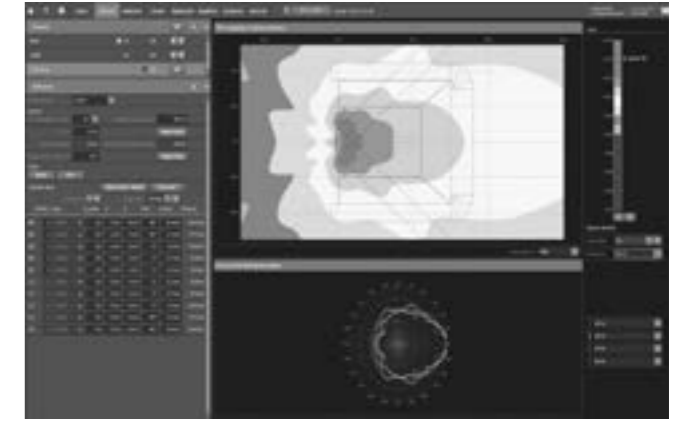

Sources, SUB array

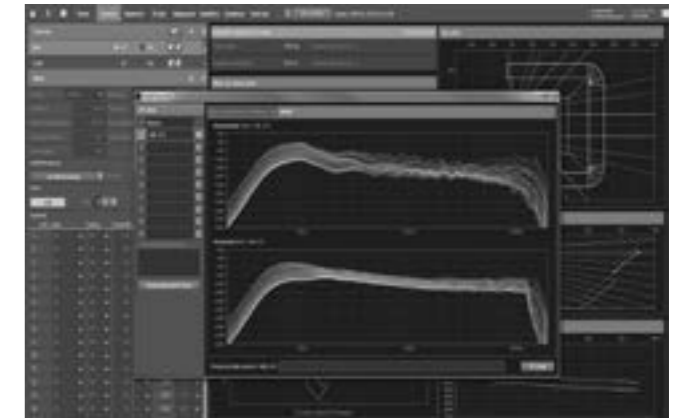

ArrayProcessing



Amplifiers

¹ Microsoft Windows is a registered trademark or trademark of Microsoft Corporation in the United States and/or other countries

² Mac OS X is a trademark of Apple Inc., registered in the U.S. and other countries

The d&b NoizCalc immission modelling software

The d&b software uses international standards to model the far field noise immission from multiple complex and coherently emitting sources such as line arrays and subwoofer arrays. More and more, gaining permission and licenses to stage live open air events requires an official statement with a prediction of how noise could impact on the surrounding area. NoizCalc takes all complex loudspeaker data and a reference point from the d&b ArrayCalc simulation software and calculates the sound propagation and relative attenuation values towards the far field for a certain scenario with particular meteorological conditions for one or more d&b loudspeaker systems.

A 3D terrain map imported from Google Maps or Street View displays the calculated immission on the areas surrounding the audience listening zones. This visual representation shows the actual system performance in the far field, enabling users to optimize for listeners while satisfying local noise restrictions and offsite regulations.

To ensure reliable results, NoizCalc includes all complex data concerning the addition and subtraction of sound waves, including phase information to describe the combination and interaction effects within a loudspeaker system consisting of multiple line arrays, subwoofer arrays and delay systems.

NoizCalc models immissions in the far field according to the internationally accepted ISO 9613-2 or Nord2000 calculation standards. Ground characteristics can be set depending on the absorbency or reflectivity of surfaces, while areas with volume attenuating properties can be defined. Buildings can be included, and the maximum reflection order option adjusts how many reflections are calculated. Parameters for humidity, air pressure and temperature ensure that the correct air absorption figures are accounted. The ISO 9613-2 standard requires limited meteorological information and assumes a worst-case scenario. The more sophisticated propagation model, Nord2000 enables a more precise handling of meteorological conditions allowing the user to model with prevailing wind information. The d&b NoizCalc immission modelling software is available at www.dbaudio.com for registered download, along with further information and video tutorials. It was developed in collaboration with SoundPLAN, a specialist software developer for environmental noise prediction.

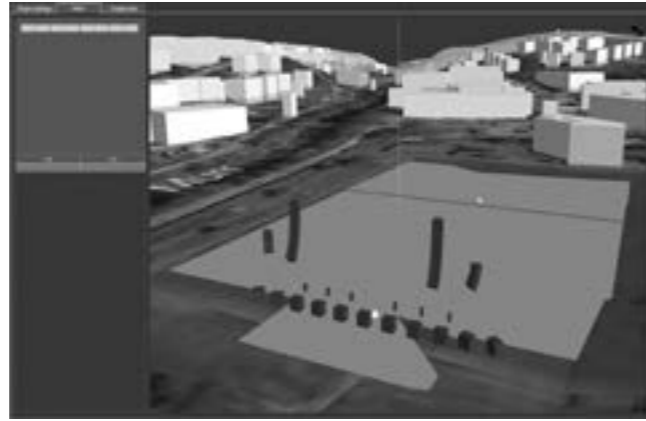

Editor



Graphic plot

The d&b Remote network

The remote control capability of the d&b Remote Network enables central control and monitoring of a complete d&b loudspeaker system from anywhere in the network, be it from a computer in the control room, at the mix position, or on a wireless tablet in the auditorium. This central access to all functions throughout the d&b Remote Network unlocks the full potential of the d&b system approach. In a typical user workflow, the d&b Remote Network takes settings optimized in the d&b ArrayCalc simulation software and applies these to all the amplifiers within the network.

All functions and controls available on the front panel of d&b amplifiers may be remotely controlled and/or monitored using the d&b R1 Remote control software. This allows each channel of the amplifier to be controlled and enables the creation of groups of loudspeakers. When grouped together, a button or fader can control the overall system level, zone level, equalization and delay, power ON/OFF, MUTE, as well as loudspeaker specific function switches such as CUT/HFA/HFC and CPL. An offline mode is provided for preparation in advance of an event, without the amplifiers being present or connected.

d&b System check verifies that the system performs within a predefined condition, while the Array verification function automatically identifies the physical position of a loudspeaker in an array to check that the system is cabled correctly. Extensive facilities for storing and recalling system settings are provided allowing these to be repeated, as and when required. For mobile applications, project files can be easily adjusted for use with a different set of equipment at another location.

The R1 software is optimized for use with touch screen, mouse and keyboard and runs on both Microsoft Windows¹ (Win7 64-bit or later) and Mac OS X² (10.12 or later).

In installation projects the R90 Touchscreen remote control can be used for quick and reliable operation of day-to-day functions of a pre-configured d&b system without needing expert level knowledge of audio. The built-in 7" panel PC provides users with one-touch control over power, mute, level, grouping and recall of up to nine AmpPresets, entirely independent of R1.

Further information is provided at www.dbaudio.com.



Home



Remote in Configuration mode



16-band equalizer

¹ Microsoft Windows is a registered trademark or trademark of Microsoft Corporation in the United States and/or other countries

² Mac OS X is a trademark of Apple Inc., registered in the U.S. and other countries

The d&b amplifiers

The d&b amplifiers are designed specifically to power d&b loudspeakers and are the beating heart of the d&b System reality. As such, they incorporate Digital Signal Processing for comprehensive loudspeaker management, switchable filter functions, remote capabilities and user-definable controls, to fulfil the exact needs of each application. Every loudspeaker configuration combines comprehensive system limiting, and equalization and crossover settings to ensure consistent results and optimal performance. d&b amplifiers offer

different output configurations for different loudspeaker setups, including Dual Channel mode, for passive setups, Mix TOP/SUB mode, in which two channels are driven through a single output connector, and 2-Way Active mode, which also sends the output of two channels down one connector to drive appropriate loudspeakers actively. The d&b switch functions provide selected filters to precisely tailor a wide variety of setups to their applications. Examples of these switch functions are the CSA (Cardioid Subwoofer Array)

and HFC (High Frequency Compensation) modes. CSA increases low frequency directivity control by minimising energy transmission towards the rear while HFC compensates for air absorption for loudspeakers covering far field listening positions. In addition to these functions, d&b amplifiers offer a comprehensive set of specific filters such as CUT, a cut mode for TOP loudspeakers when used with d&b subwoofers; CPL, to compensate for the coupling effect between loudspeakers in close proximity to other loudspeakers or hard objects and HFA

mode, to attenuate the high frequencies of a loudspeaker to mimic the effect of far field listening. These devices offer extended, user-definable equalization and delay capabilities, eliminating the need for external processing devices in the signal chain. All d&b amplifiers integrate with the d&b Remote network to enable the remote control and management of systems from anywhere within a network. Further information is provided in the d&b Amplifier and Software brochure which is available for download at www.dbaudio.com.

Comparison of the d&b amplifiers

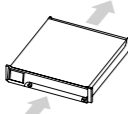
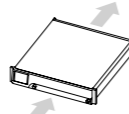
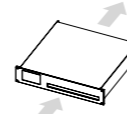
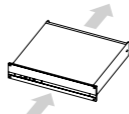
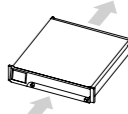
	D80	D40	40D	30D	D20
User interface	Encoder/colour TFT touchscreen	Encoder/colour TFT touchscreen	Colour TFT touchscreen	LED indicators	Encoder/colour TFT touchscreen
Output channels	4	4	4	4	4
Input channels	4 x AES3 or 4 x analog or 2 x AES3 and 2 x analog	4 x AES3 or 4 x analog	4 x AES3 and 4 x analog	4 x AES3 and 4 x analog	4 x AES3 or 4 x analog or 2 x AES3 and 2 x analog
Latency	0.3 msec	0.3 msec	0.3 msec	0.3 msec	0.3 msec
User equalizers (per channel)	2 x 16-band	2 x 16-band	2 x 16-band	2 x 16-band	2 x 16-band
Delay	10 sec/3440 m	10 sec/3440 m	10 sec/3440 m	10 sec/3440 m	10 sec/3440 m
Maximum output power (THD+N < 0.5%, 12 dB crest factor)	4 x 2000 W into 8 ohms 4 x 4000 W into 4 ohms	4 x 2000 W into 8 ohms 4 x 2400 W into 4 ohms	4 x 2000 W into 8 ohms 4 x 2400 W into 4 ohms	4 x 800 W into 8 ohms 4 x 1600 W into 4 ohms	4 x 800 W into 8 ohms 4 x 1600 W into 4 ohms
Output routing	Dual Channel, Mix TOP/SUB 2-Way Active	Dual Channel, Mix TOP/SUB 2-Way Active	Dual Channel, Mix TOP/SUB 2-Way Active	Dual Channel, Mix TOP/SUB 2-Way Active	Dual Channel, Mix TOP/SUB 2-Way Active
Output connectors	NL4 plus central NL8	NL4 plus central NL8	Phoenix Euroblock	Phoenix Euroblock	NL4 plus central NL8
GPIO connector	No	No	Phoenix Euroblock 12 ports	Phoenix Euroblock 5 ports	No
Cable compensation	LoadMatch	LoadMatch	LoadMatch	LoadMatch	LoadMatch
Power supply	Autosensing switched mode power supply with active PFC	Autosensing switched mode power supply with active PFC	Autosensing switched mode power supply with active PFC	Universal range switched mode power supply with active PFC	Universal range switched mode power supply with active PFC
Mains voltage	100 - 127/208 - 240 V, 50 - 60 Hz	100 - 127/208 - 240 V, 50 - 60 Hz	100 - 127/208 - 240 V, 50 - 60 Hz	100 - 240 V, 50 - 60 Hz	100 - 240 V, 50 - 60 Hz
Weight (kg/lb)	19/42	13,8/30,4	13,3/29,3	10,6/23,4	10,8/23,8
Dimensions	2 RU x 19" x 530 mm	2 RU x 19" x 465 mm	2 RU x 19" x 465 mm	2 RU x 19" x 435 mm	2 RU x 19" x 460 mm
Remote	OCA via Ethernet/CAN	OCA/AES70 via Ethernet	OCA/AES70 via Ethernet	OCA via Ethernet/CAN	OCA via Ethernet/CAN
Airflow					

The controller setups and operation with d&b amplifiers

Arc and Line mode

The Arc mode is intended for line array loudspeakers when used in curved array sections. The Line mode is used for long throw array sections with three or more consecutive splay settings of 0°, 1° or 2°. Compared to the Arc mode, the mid/high range is reduced to compensate for the extended near field.

AP setup

In connection with ArrayProcessing (AP), the AP setup contains the AP data that are generated in the ArrayCalc simulation software. These are transferred to the applicable amplifiers via the d&b Remote network (OCA/AES70) using R1.

CUT mode

Set to CUT, the cabinet low frequency level is reduced and it is now configured for use with the d&b V or J subwoofers.

HFC mode

Selecting the HFC (High Frequency Compensation) mode compensates for loss of high frequency energy due to absorption in air when loudspeakers are used to cover far field listening positions. HFC has two settings which should be used selectively, HFC1 for cabinets covering distances larger than 30 m (100 ft) and HFC2 for those covering distances larger than 60 m (200 ft). This can be used to achieve the correct sound balance between close and remote audience areas allowing all amplifiers driving the array to be fed from the same signal source.

HFA mode

In HFA mode (High Frequency Attenuation), the HF response of the system is rolled off. HFA provides a natural, balanced frequency response when a unit is placed close to listeners in near field or delay use. HFA begins gradually at 1 kHz, dropping by approximately 3 dB at 10 kHz. This roll off mimics the decline in frequency response experienced when listening to a system from a distance in a typically reverberant room or auditorium.

CPL function

The CPL (Coupling) function compensates for coupling effects between the cabinets of an array. CPL begins gradually around 2 kHz, with the maximum attenuation below 100 Hz.

100 Hz mode

The 100 Hz mode limits the upper operating frequency of the subwoofer to 100 Hz, complementing top cabinets in full range mode.

Recommended amplifiers for mobile applications

	V7P	V10P	V-GSUB	V8	V12	V-SUB
D40	x	x	x	x	x	x
D80	x	x	x	x	x	x

Recommended amplifiers for installation applications

	Vi7P	Vi10P	Vi-GSUB	Vi8	Vi12	Vi-SUB
30D	x	x	x	x	x	x
40D	x	x	x	x	x	x

Maximum loudspeakers per amplifier channel

	V7P	V10P	V-GSUB	V8	V12	V-SUB
	Vi7P	Vi10P	Vi-GSUB	Vi8	Vi12	Vi-SUB
	2	2	2	2	2	2

Available controller settings

	V7P	V10P	V-GSUB	V8	V12	V-SUB
	Vi7P	Vi10P	Vi-GSUB	Vi8	Vi12	Vi-SUB
Arc/Line				x	x	
AP				x	x	x
CUT	x	x		x	x	
HFC				x	x	
HFA	x	x				
CPL	x	x		x	x	
100 Hz			x			x

The V-Series frequency responses

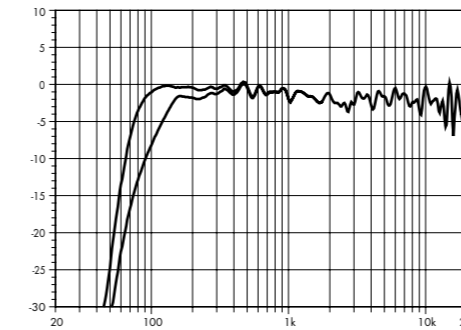

V7/Vi7P standard and CUT (single cabinet)

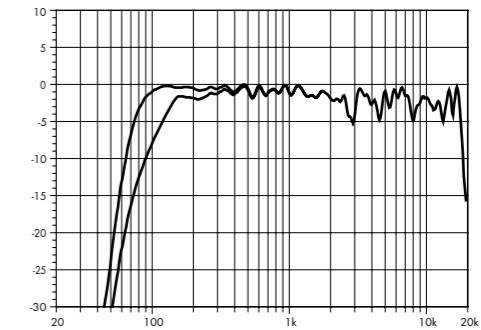

V10/Vi10P standard and CUT (single cabinet)

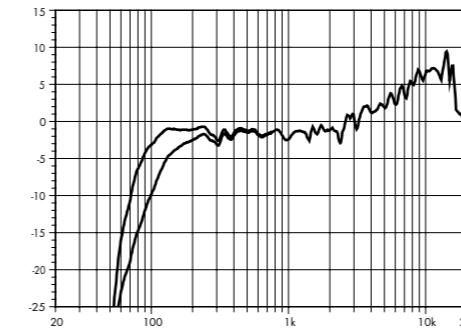

V8/Vi8 standard and CUT (single cabinet)

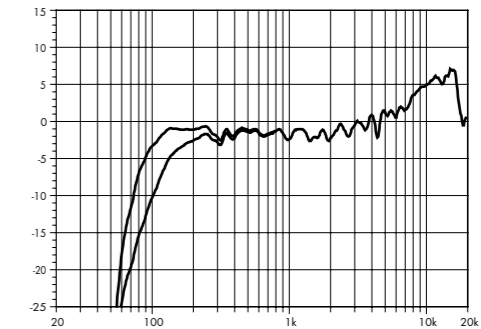

V12/Vi12 standard and CUT (single cabinet)

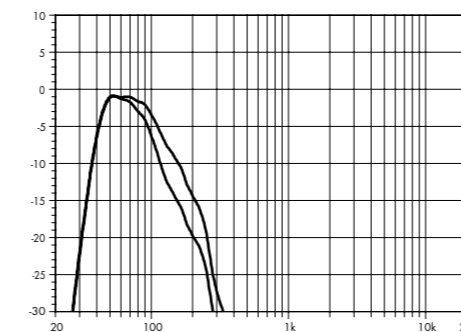

V-SUB/Vi-SUB and V-GSUB/Vi-GSUB standard and 100 Hz

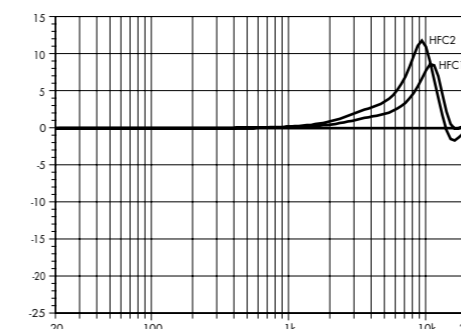

Correction of HFC*
*schematic diagram

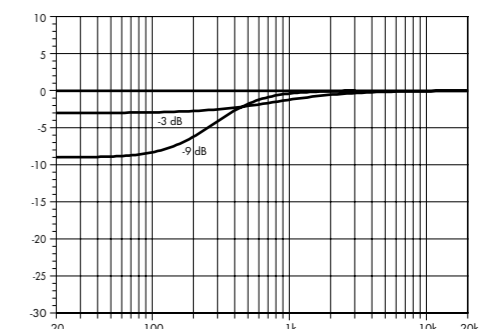

Correction of CPL*
*schematic diagram

The d&b amplifier output modes

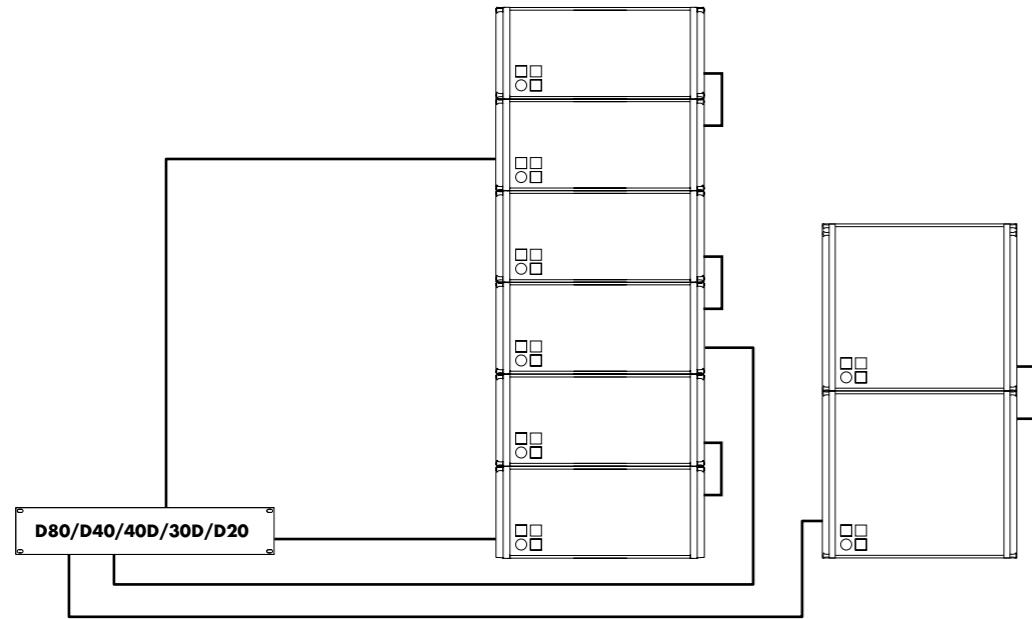

D80/D40/40D/30D/D20 amplifier in Dual Channel mode for V7P, V10P, Vi7P, Vi10P, V8, Vi8, V12, Vi12 as well as V-GSUB, Vi-GSUB, V-SUB and Vi-SUB

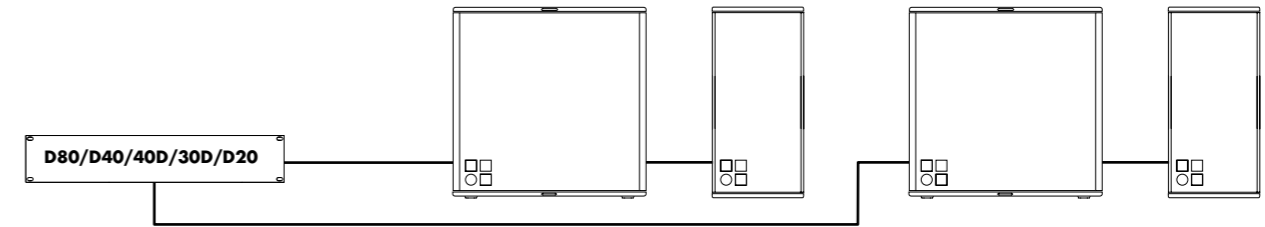

D80/D40/40D/30D/D20 amplifier in Mix TOP/SUB mode for V7P, V10P, Vi7P, Vi10P, V8, V12, Vi8, Vi12 as well as V-GSUB, Vi-GSUB, V-SUB and Vi-SUB

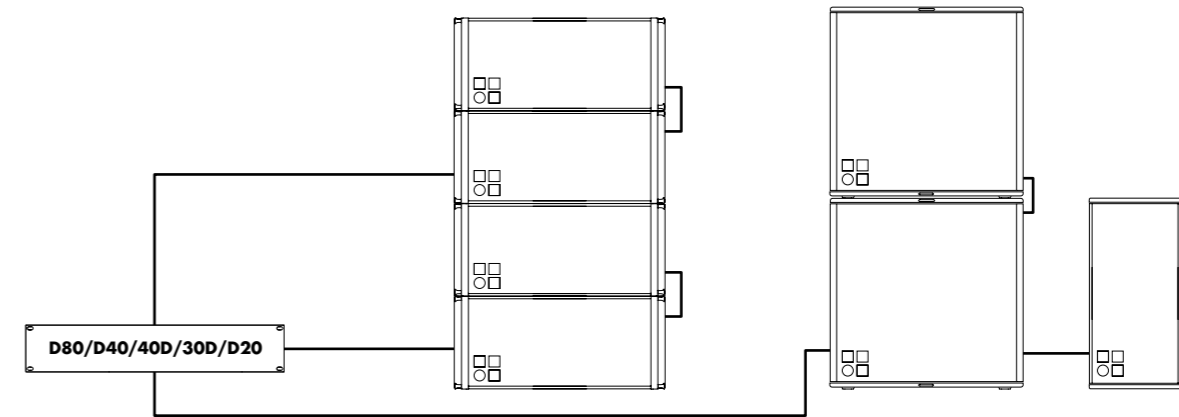

D80/D40/40D/30D/D20 amplifier in a mixed configuration of Dual Channel and Mix TOP/SUB mode for V7P, V10P, Vi7P, Vi10P, V8, V12, Vi8, Vi12 as well as V-GSUB, Vi-GSUB, V-SUB and Vi-SUB

The DS10 and DS20 Audio network bridges

The DS100 Signal Engine

DS10 Audio network bridge

The DS10 Audio network bridge interfaces between Dante networks and AES3 digital audio signals, while also providing distribution of Ethernet control data. Positioned within the signal chain in front of the amplifiers, this 1 RU device expands the d&b system approach. Each unit can deliver up to sixteen Dante network channels via AES3 digital signal outputs. Additionally, four AES3 input channels provide access to the Dante audio network for applications such as a break-in from a Front of House console. The DS10 incorporates an integrated 5-port switch, offering a primary and redundant network for the Dante protocol, as well as advanced functions such as Multicast Filtering and VLAN modes. Using the DS10 Audio network bridge, audio signals and remote control data can be combined using a single Ethernet cable.



The DS10 Audio network bridge front view



The DS10 Audio network bridge rear view

DS20 Audio network bridge

The DS20 Audio network bridge supports the open standards-based Milan protocol rather than Dante. Milan (Media integrated local area networking) is a high level interoperability solution based on Audio Video Bridging (AVB) technology. The main advantages are deterministic behaviour (zero network congestion); improved reliability; optimum synchronization and hassle free network setup, as no special settings, such as QoS, need to be set within the switches to ensure delivery.



The DS20 Audio network bridge front view



The DS20 Audio network bridge rear view

DS100 Signal Engine

The d&b DS100 Signal Engine is the platform underneath the Soundscape, based on a specialized rack mount 3 RU audio processor with Audinate Dante networking. It provides a 64 x 64 audio matrix with level and delay adjustments at all cross points. Additional software modules provide dynamic source positioning and emulated acoustics functions. The DS100 is a versatile tool for use within complex audio systems to route and distribute multiple audio channels to numerous amplifiers driving loudspeaker positions and zones, show relay and break out rooms. The networking capabilities with a Dante enabled processor are significant, particularly for busy, multi-room complexes. The DS100 completely integrates with the overall d&b system approach, including loudspeakers, amplifiers, rigging, transport and networking accessories and the DS10 Audio network bridge. The complete system is designed and optimized in the d&b ArrayCalc simulation software, and controlled via the d&b R1 Remote control software.



The DS100 Signal Engine front view

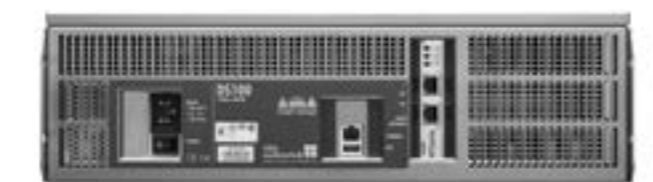

The DS100 Signal Engine rear view

The V-Series configuration examples

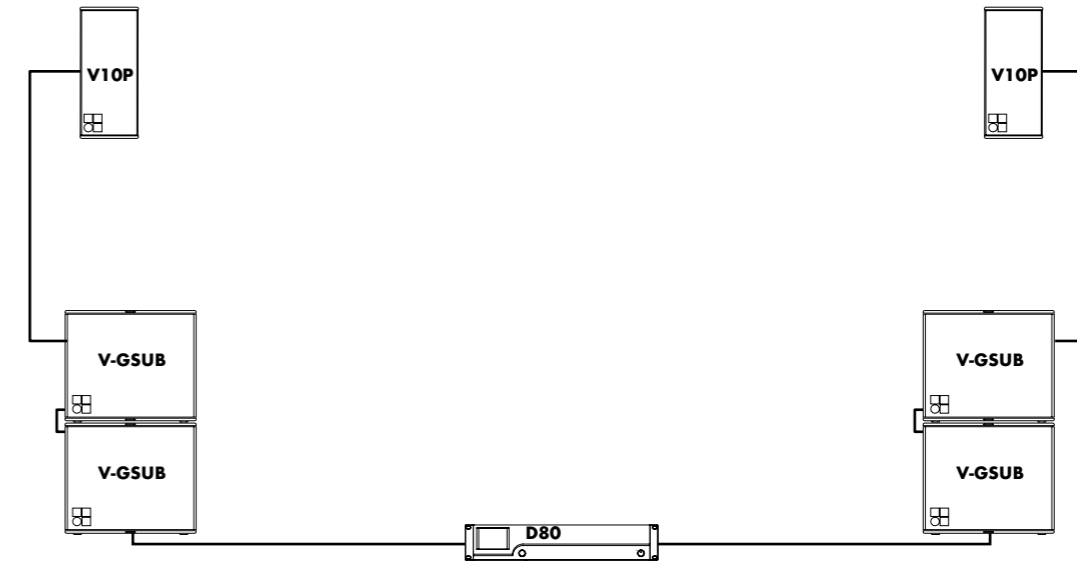

V-Series L/R configuration comprising V10Ps and V-GSUBs with a D80 amplifier in Mix TOP/SUB mode

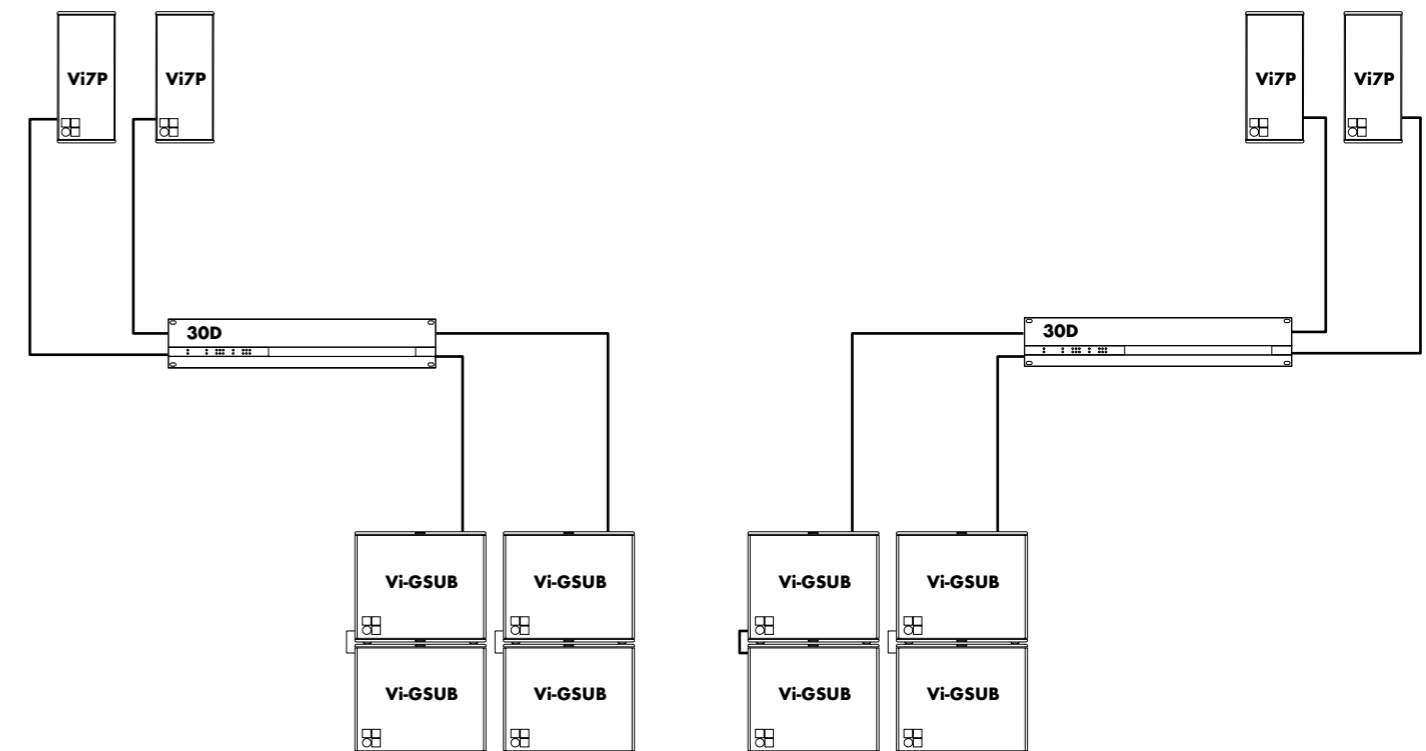

Vi7P loudspeakers in a distributed point source system and ground stacked Vi-GSUBs, with 30D amplifiers in Dual Channel mode

The V-Series configuration examples

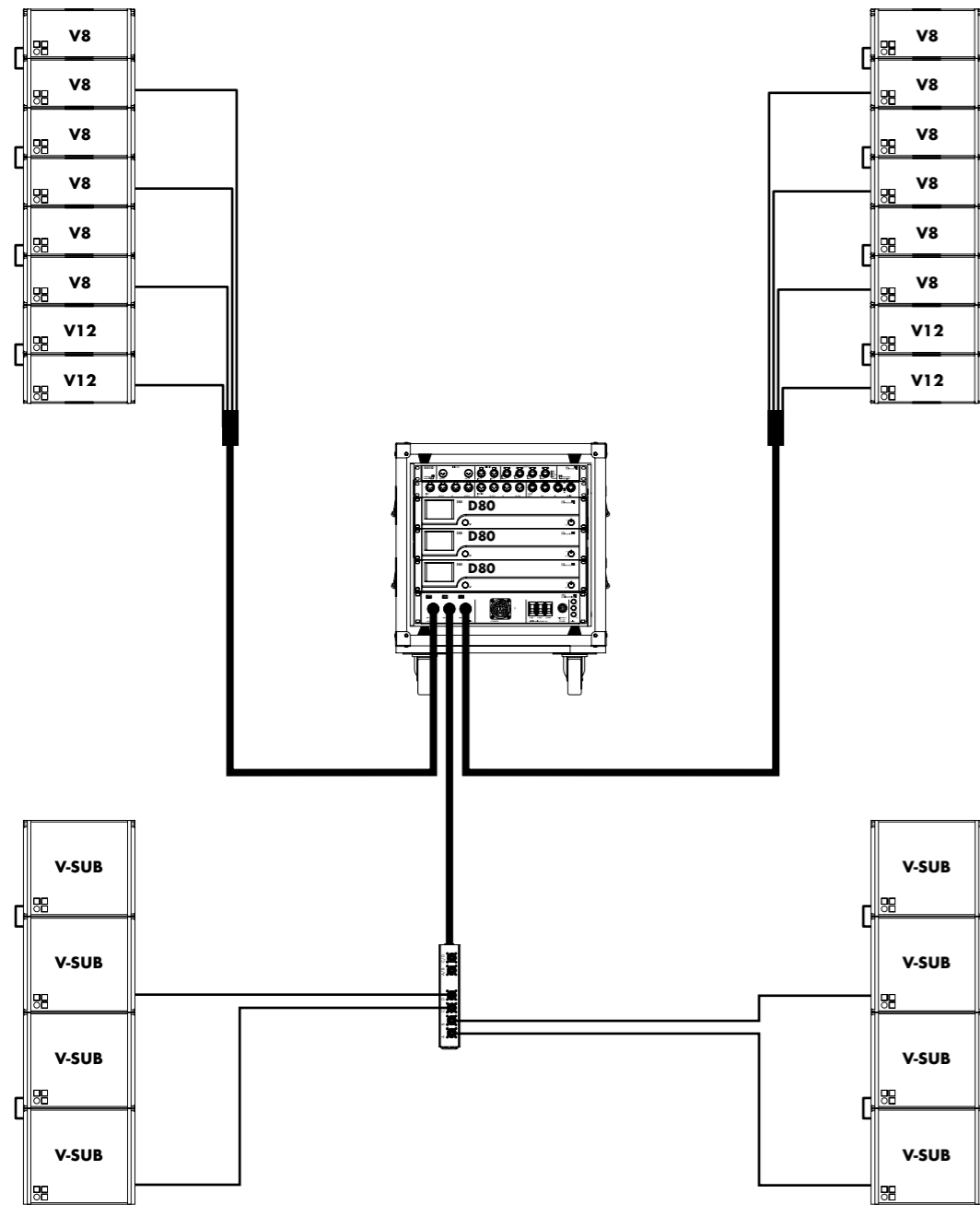

V-Series L/R configuration with V8/V12 flown line array and ground stacked V-SUBs with D80 Touring rack

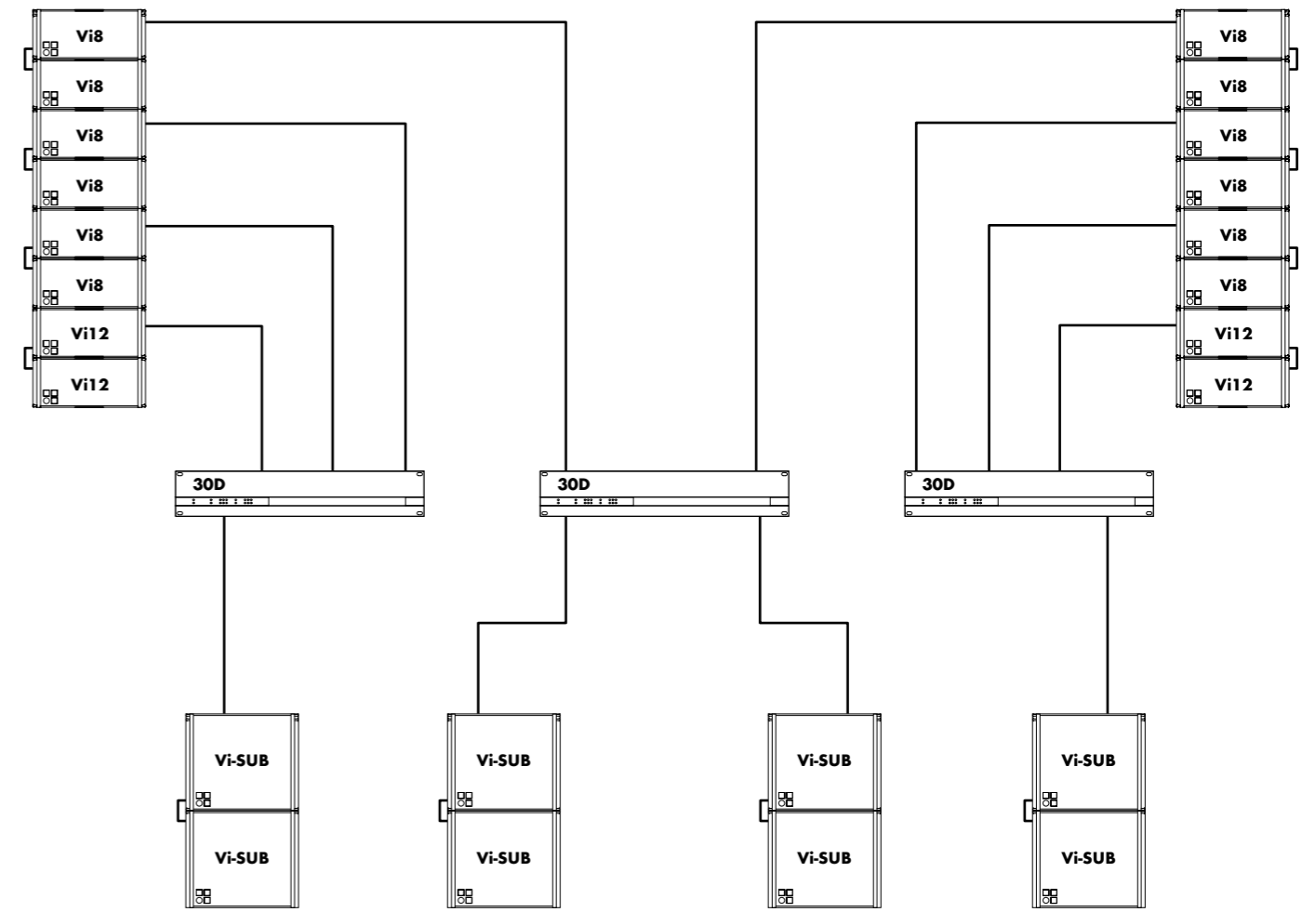

Vi line array in L/R configuration with flown Vi8/Vi12s with ground stacked Vi-SUBs with 30D amplifiers in Dual Channel mode

The V-Series configuration examples

The V-Series configuration examples with ArrayProcessing

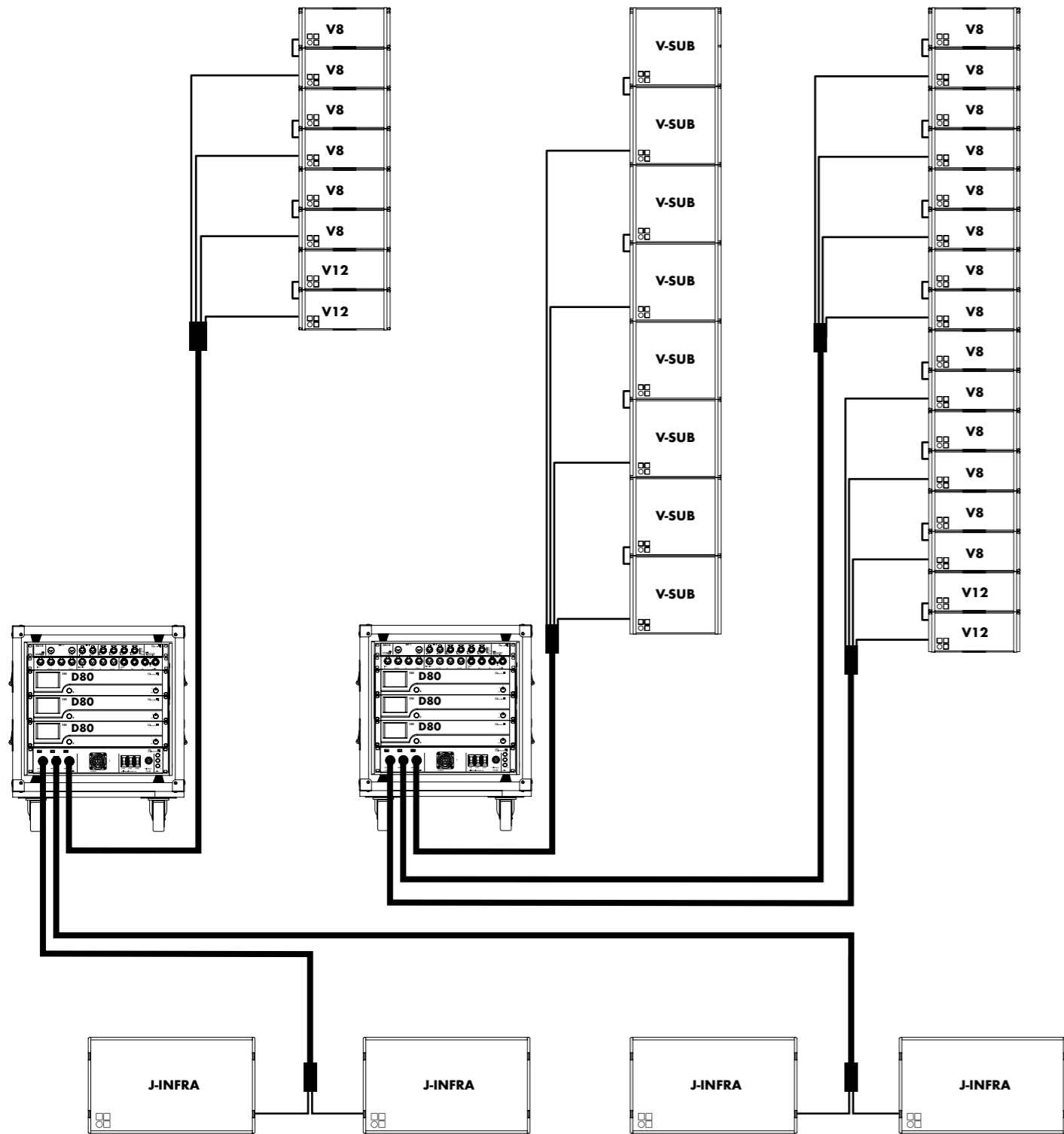

V8/V12 and V-SUB main arrays, V8/V12 outfills and ground stacked J-INFRAs with D80 Touring racks¹

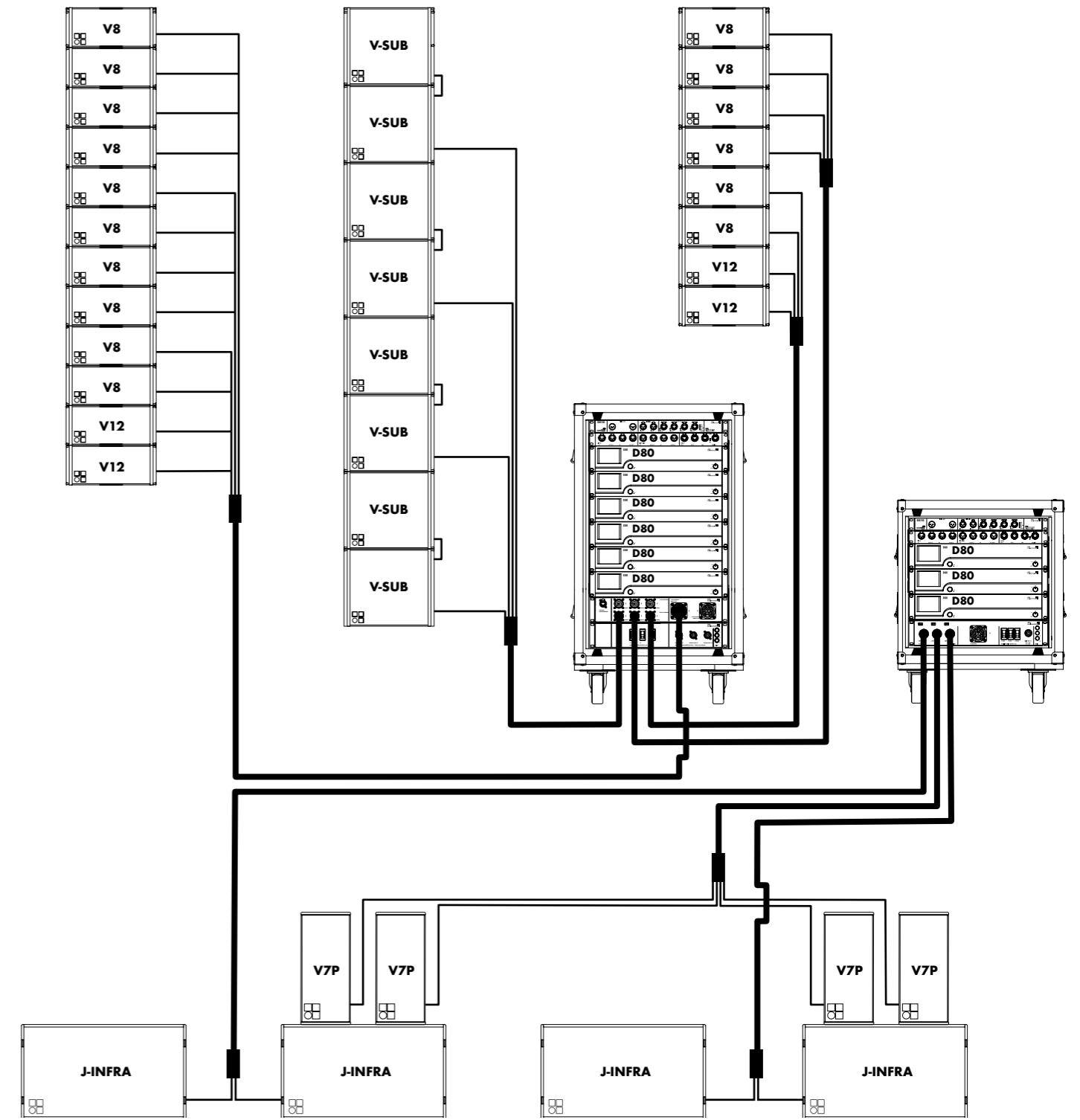

V8/V12 main array and V8/V12 outfills driven with ArrayProcessing with flown V-SUB array and ground stacked J-INFRAs and V7P nearfills with D80 Touring racks¹

The V-Series configuration examples with ArrayProcessing

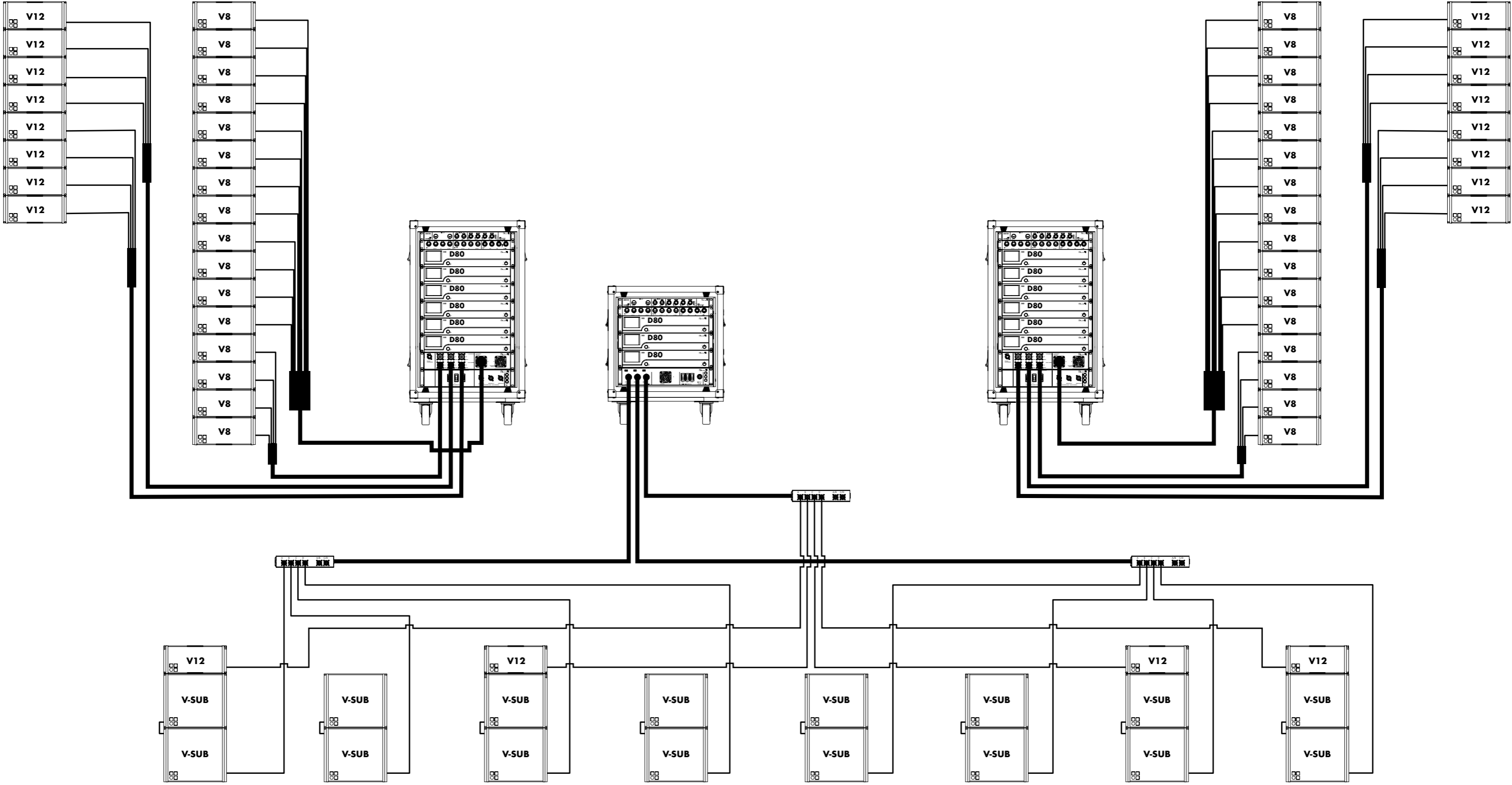

V-Series configuration comprising V8 mains and V12 outfill arrays driven with ArrayProcessing along with ground stacked V-SUBs and V12 as nearfills with D80 Touring racks¹

¹ These configurations are also valid for Vi loudspeakers

The V-Series cables and adapters MC8/MC24

Amplifiers in Dual Channel mode

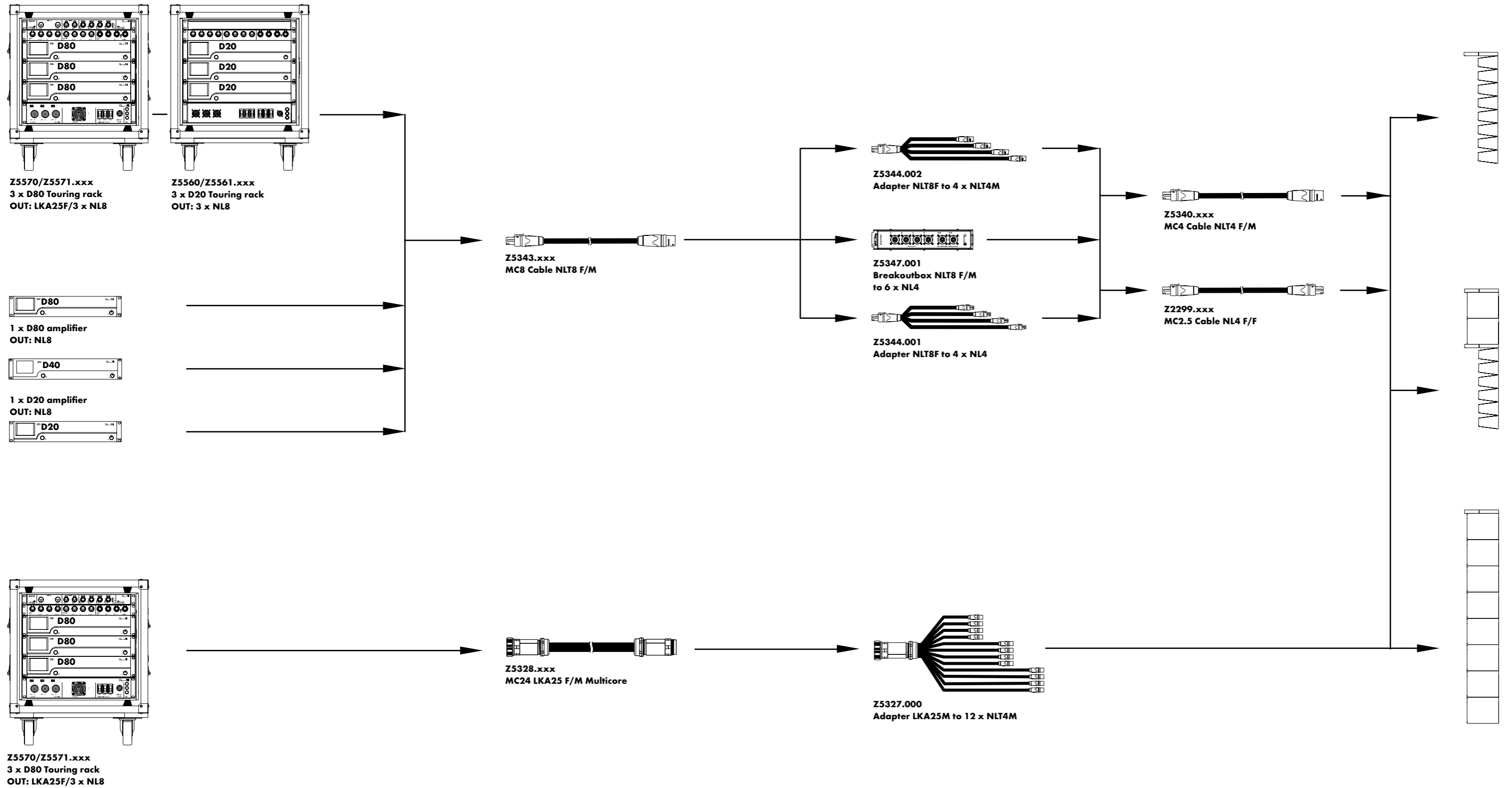

The V-Series cables and adapters MC8/MC24

Amplifiers in Dual Channel mode

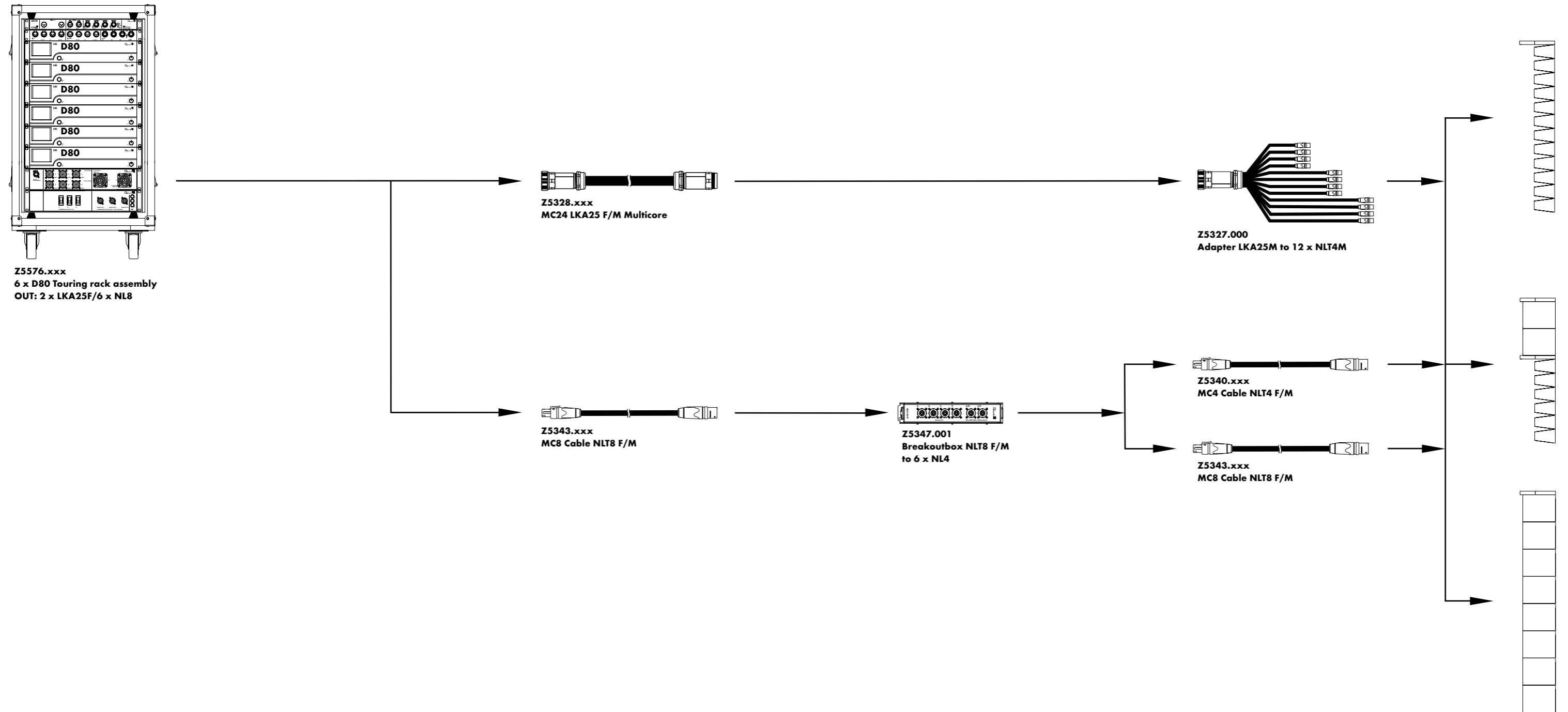

The V-Series product overview

V loudspeakers	Z0704.xxx Z0705.xxx Z0515.xxx Z0516.xxx Z0518.xxx Z0519.xxx	V7P loudspeaker V10P loudspeaker V8 loudspeaker V12 loudspeaker V subwoofer V-GSUB	Z5010.000 Z5012.500 Z5049.000 Z5013.000 Z5009.000 Z5024.000	TV Spigot with fixing plate Pipe clamp for TV Spigot Flying pin 8mm M20 pole with winder Loudspeaker stand with winder Loudspeaker stand adapter
Loudspeaker connector options	Zxxxx.002 Zxxxx.001	NLT4 F/M connector NL4 connector	Remote network Z6118.000 Z6124.000	R60 USB to CAN interface R70 Ethernet to CAN interface
Vi loudspeakers	Z0724.001 Z0725.001 Z0535.001 Z0536.001 Z0538.001 Z0520.001	Vi7P loudspeaker NL4 connector Vi10P loudspeaker NL4 connector Vi8 loudspeaker NL4 connector Vi12 loudspeaker NL4 connector Vi subwoofer NL4 connector Vi-GSUB NL4 connector	Processing and distribution Z4010.000 Z4011.000 Z4100.000	DS10 Audio network bridge DS20 Audio network bridge DS100 Signal Engine
		WR Weather Resistant option ¹ SC Special Colour option ²	Amplifiers Z2710.xxx Z2850.xxx Z2830.xxx Z2770.xxx Z2750.xxx	D80 amplifier ⁴ D40 Amplifier ⁴ 40D Amplifier ⁵ 30D Amplifier ⁵ D20 Amplifier ⁴
Loudspeaker cases	E7462.000 E7465.000 E7466.000	Touring case 2 x V8/V12 Touring case 2 x V Flying frame Touring case 2 x V7P/V10P	Amplifier rack assemblies Z5560.xxx Z5561.xxx Z5570.xxx Z5571.xxx Z5576.xxx	3 x D20 Touring rack ⁶ 3 x D20 Touring rack (includes DS10) ⁶ 3 x D80 Touring rack ⁶ 3 x D80 Touring rack (includes DS10) ⁶ 6 x D80 Touring rack (includes DS10) ⁶
Loudspeaker carts	E7463.000 E7464.000	Touring cart 4 x V8/V12 Touring cart 8 x V8/V12	Racks E7480.000 E7468.000 E7483.000	D20 Touring rack 2 RU, 19" SD, shock mounted, handles D80 Touring rack 2 RU, 19" SD, shock mounted, handles DS100 Touring rack 3 RU, 19" SD, shock mounted, handles
Lids	E7923.000 E7926.000	V-SUB Wooden lid V-GSUB Wooden lid	Cables and adapters Z5339.000 Z5343.xxx Z5345.001 Z5344.002 Z5344.001 Z5347.001 Z5340.xxx Z5328.xxx Z5327.000 Z2299.xxx Z5763.000	Multichannel extension cable 6,35/6,45/7,15/7,45 m MC8 Cable NLT8 F/M 5/10/15/20/30/45 m Adapter 4 x NL4 to NLT8M 0,6/1,2/1,8/2,4m Adapter NLT8F to 4 x NLT4M 0,6/1,2/1,8/2,4m Adapter NLT8F to 4 x NL4 0,6/1,2/1,8/2,4m Breakoutbox NLT8 F/M to 6 x NL4 MC4 Cable NLT4 F/M 1/3/5/10/15/20m MC24 LKA 25 F/M Multicore 10/15/20/25/27,5/30m Adapter LKA25M to 12 x NLT4M MC2.5 Cable NL4 F/F 1/3/5/10/15/20/25/50m WR 5,5m cable 2x2.5mm ^{2,7} 5,5m
V/Vi accessories	Z5380.000 Z5776.000 Z5775.000	V Flying frame ³ (supplied with Z5775 Safety chainset) Hoist connector chain Safety chainset 2t	Alignment tools Z5710.002 Z5762.000	d&b ArraySight set V Series d&b ArraySight meter unit
V accessories	Z5385.000 Z5386.000 Z5147.000	V Flying adapter V Stack adapter Rota clamp		
Vi accessories	Z5387.000 Z5387.001 E6507.000 Z5383.000 Z5384.000 Z5388.000 Z5551.000 Z5550.000	Vi Mounting frame top ³ Vi Mounting frame bottom ³ 1t ShackleVP accessories VP Mounting bracket ³ VP Flying adapter ³ VP Horizontal bracket ³ VP Flying adapter link M20 Stand adapter		

¹ WR only for Vi loudspeakers, on request

² SC only for Vi loudspeakers

³ SC on request

⁴ The complete list of mobile amplifier versions is available in the d&b D Amplifier and Software brochure

⁵ The complete list of installation amplifier versions is available in the d&b xD Installation Amplifier and Software brochure

⁶ Further information is available in the d&b D Amplifier and Software brochure

⁷ Other lengths on request

